

STATE OF INDIANA
BEFORE THE BOARD OF CLARK COUNTY COMMISSIONERS

ORDINANCE NO. 40 -2024

**AN ORDINANCE ADOPTING THE CLARK COUNTY STORMWATER
MANAGEMENT ORDINANCE AND THE
STORMWATER TECHNICAL STANDARDS MANUAL**

WHEREAS, the Board of Commissioners of Clark County, Indiana (the “Board”), is the executive body of Clark County Government pursuant to the provisions of Ind. Code § 36-2-2-2; and,

WHEREAS, the Board is also the legislative body of Clark County Government pursuant to the provisions of Ind. Code 36-1-2-9; and,

WHEREAS, the current Clark County Stormwater Management Ordinance and related Stormwater Technical Standards and other related ordinances are in need of certain required updates, revisions and additions to be in compliance with current Indiana law and with other current Indiana rules and regulations;

WHEREAS, the Board now finds it necessary to adopt a new Stormwater Management Ordinance and new Stormwater Technical Standards Manual for Clark County, attached hereto as **Exhibit “A” and Exhibit “B”** for the purposes stated in the preceding paragraph.

NOW, THEREFORE, BE IT ORDAINED by the Board of Clark County Commissioners as follows:

1. That the Clark County Stormwater Management Ordinance and Stormwater Technical Standards Manual for Clark County are hereby adopted as attached hereto as **Exhibit “A” and Exhibit “B”**.

2. This Ordinance shall be in full force and effect upon its passage and promulgation as evidenced by the affirmative signatures of the undersigned as the majority of the duly elected and serving members of this Board,

3. That the Stormwater Management Ordinance and the Stormwater Technical Standards Manual as attached hereto as **Exhibit "A"** and **Exhibit "B"** shall supersede and replace any conflicting ordinances, resolutions or other provisions adopted by Clark County.

So Ordained this 19th day of December, 2024.

Members voting "NO":

Bryan Glover, Commissioner

Connie Sellers, Commissioner

Jack Coffman, Commissioner

Members voting "YES":



Bryan Glover, Commissioner

Absent

Connie Sellers, Commissioner



Jack Coffman, Commissioner

Attested by:



Danny Yost, Clark County Auditor

**STORMWATER MANAGEMENT
ORDINANCE
CLARK COUNTY, INDIANA**

EXHIBIT “A”

Abbreviated Table of Contents

Section	Title
1	GENERAL INFORMATION
2	Prohibited Discharges and Connections
3	Stormwater Quantity Management
4	Stormwater Pollution Prevention for Construction Sites
5	Stormwater Quality Management for Post-Construction
6	Permit Requirements and Procedures
7	Compliance and Enforcement
Appendices A	Abbreviations and Definitions

SECTION 1

General Information

(a) AUTHORITY AND TITLE

This Ordinance is adopted in accordance with statutory authority granted to Clark County under "Home Rule" and further is required by Phase II of the National Pollutant Discharge Elimination System Stormwater program (40 CFR Parts 9, 122, 123, and 124; December 8, 1999) authorized by the 1987 amendments to the Clean Water Act, the Indiana Department of Environmental Management's (IDEM) Municipal Separate Storm Sewer System (MS4) General Permit (MS4 GP), and the Indiana Department of Environmental Management's Construction Stormwater General Permit (CSGP). Based on this authority and these requirements, this Ordinance regulates:

- i. Discharges of prohibited non-stormwater flows into the storm drain system.
- ii. Stormwater drainage improvements related to development of lands located within the corporate boundaries of the Clark County.
- iii. Drainage control systems installed during new construction and grading of lots and other parcels of land.
- iv. Stormwater, including stormwater runoff, snowmelt runoff, and surface runoff and drainage, associated with construction activity
- v. Stormwater discharges from construction support activities directly related to construction sites subject to this ordinance.
- vi. Erosion and sediment control systems installed during new construction and grading of lots and other parcels of land.
- vii. The design, construction, and maintenance of stormwater drainage facilities and systems.
- viii. The design, construction, and maintenance of stormwater quality facilities and systems.

This Ordinance shall be known and may be cited as the Clark County Stormwater Management Ordinance and administered by the Clark County Drainage Board (CCDB). Once adopted, this Ordinance will supersede any conflicting ordinances previously adopted by the Clark County.

(b) APPLICABILITY AND EXEMPTIONS

This Ordinance shall regulate all development and redevelopment occurring within the Clark County. No building permit shall be issued and no land disturbance started for any construction in a development, as defined in Appendix A, until the plans required by this Ordinance for such construction have been accepted in writing by the CCDB or its designee. With the exception of the requirements of Section 2 and Section 6(d) of this Ordinance, single-family dwelling houses and duplexes in accepted subdivisions, and land-disturbing activities affecting less than 10,000 square feet of area shall be exempt from the requirements of this Ordinance. Also exempt from this Ordinance shall be agricultural land-disturbing activities.

In addition to the requirements of this Ordinance and its companion Stormwater Technical Standards Manual, compliance with all applicable ordinances of Clark County as well as with applicable Federal, State of Indiana, and other Local statutes and regulations shall also be required. Unless otherwise stated, all other specifications referred to in this Ordinance shall be the most recent edition available. Clark County capital improvement projects shall be exempt from obtaining a permit, but are expected to meet all applicable technical requirements of this Ordinance and the Clark County Stormwater Technical Standards Manual. In case there are conflicts between the requirements contained in this Ordinance and applicable requirements contained in other regulatory documents referenced above, the most restrictive shall prevail.

Any construction project which has had its final drainage plan accepted by the CCDB or its designee within a 2-year period prior to the effective date of this Ordinance shall be exempt from all requirements of this Ordinance

that are in excess of the requirements of ordinances in effect at the time of acceptance. Such an exemption is not applicable to the requirements detailed in Section 2 of this Ordinance.

The CCDB or its designee has the authority to modify, grant exemptions, and/or waive any and all the requirements of this Ordinance and its associated technical standards document. A pre-submittal meeting with the CCDB or its designee may be requested by the applicant to discuss the applicability of various provisions of the Ordinance and its associated technical standards document with regards to unique or unusual circumstances relating to a project. However, any initial determination of such applicability shall not be binding on future determinations of the CCDB or its designee that may be based on the review of more detailed information and plans.

(c) FINDINGS

The Clark County finds that:

1. Water bodies, roadways, structures, and other property within the Clark County or its planning jurisdiction boundary are at times subjected to flooding;
2. Flooding is a danger to the lives and property of the public and is also a danger to the natural resources of the region;
3. Land development alters the hydrologic response of watersheds, resulting in increased stormwater runoff rates and volumes, increased flooding, increased stream channel erosion, and increased sediment transport and deposition;
4. Soil erosion resulting from land-disturbing activities causes a significant amount of sediment and other pollutants to be transported off-site and deposited in ditches, streams, wetlands, lakes, and reservoirs;
5. Increased stormwater runoff rates and volumes, and the sediments and pollutants associated with stormwater runoff from future development projects within the Clark County will, absent reasonable regulation and control, adversely affect the Clark County's water bodies and water resources;
6. Pollutant contributions from illicit discharges within the Clark County will, absent reasonable regulation, monitoring, and enforcement, adversely affect the Clark County's water bodies and water resources;
7. Stormwater runoff, soil erosion, non-point source pollution, and illicit sources of pollution can be controlled and minimized by the regulation of stormwater management;
8. Adopting the standards, criteria, and procedures contained and referenced in this Ordinance and implementing the same will address many of the deleterious effects of stormwater runoff and illicit discharges;
9. Adopting this Ordinance is necessary for the preservation of the public health, safety, and welfare, for the conservation of natural resources, and for compliance with State and Federal regulations.

(d) PURPOSE

The purpose of this Ordinance is to provide for the health, safety, and general welfare of the citizens of the Clark County through the regulation of stormwater and non-stormwater discharges to the storm drainage system and to protect, conserve and promote the orderly development of land and water resources within the Clark County. This Ordinance establishes methods for managing the quantity and quality of stormwater entering into the storm drain system. The objectives of this Ordinance are:

- i. To reduce the hazard to public health and safety caused by excessive stormwater runoff.
- ii. To regulate the contribution of pollutants to the storm drain system from construction site runoff.
- iii. To regulate the contribution of pollutants to the storm drain system from runoff from new development and re-development.
- iv. To prohibit illicit discharges into the storm drain system.
- v. To establish legal authority to carry out all inspection, monitoring, and enforcement procedures necessary to ensure compliance with this ordinance.

(e) ABBREVIATIONS AND DEFINITIONS

For the purpose of this Ordinance, the abbreviations and definitions provided in Appendix A shall apply.

(f) RESPONSIBILITY FOR ADMINISTRATION

The CCDB or its designee shall administer, implement, and enforce the provisions of this Ordinance. Any powers granted or duties imposed upon the authorized enforcement agency may be delegated in writing by the CCDB or its designee to qualified persons or entities acting in the beneficial interest of or in the employ of the CCDB or its designee.

(g) INTERPRETATION

Words and phrases in this Ordinance shall be construed according to their common and accepted meanings, except that words and phrases defined in Appendix A, shall be construed according to the respective definitions given in that section. Technical words and technical phrases that are not defined in this Ordinance, but which have acquired particular meanings in law or in technical usage shall be construed according to such meanings.

(h) SEVERABILITY

The provisions of this Ordinance are hereby declared severable, and if any court of competent jurisdiction should declare any part or provision of this Ordinance invalid or unenforceable, such invalidity or unenforceability shall not affect any other part or provision of this Ordinance.

(i) DISCLAIMER OF LIABILITY

The degree of protection required by this Ordinance is considered reasonable for regulatory purposes and is based on historical records, engineering, and scientific methods of study. Larger storms may occur or stormwater runoff amounts may be increased by man-made or natural causes. This Ordinance does not imply that land uses permitted will be free from stormwater damage. This Ordinance shall not create liability on the part of the CCDB or its designee or any officer, representative, or employee thereof, for any damage that may result from reliance on this Ordinance or on any administrative decision lawfully made there under.

The words “approve” and “accept”, and their common derivations as used in this Ordinance in relation to plans, reports, calculations, and permits shall mean that CCDB or its designee has reviewed the material produced and submitted by the applicant or his/her agents for general compliance with this Ordinance and the Clark County Stormwater Technical Standards Manual, and that such compliance would qualify the applicant to receive a stormwater management approval or permit. Such an “approval” or “acceptance” is based on the assumption that the project engineer has followed all appropriate engineering methods in the design. Any stormwater quantity (drainage) or water quality problems associated with the project caused by poor construction by the contractor and/or poor engineering design or judgment, either on-site or off-site, are the responsibility of the developer and the project engineer.

Consideration, design, construction, and maintenance of safety measures for proposed or existing stormwater facilities shall be the responsibility of the developer, applicant, and/or the property owner. CCDB or its designee and its officials and representatives shall not be responsible for maintenance nor liability for any accidents.

SECTION 2

Prohibited Discharges and Connections

(a) APPLICABILITY AND EXEMPTIONS

This section shall apply to all discharges, including illegal dumping, entering the storm drain system under the control of the Clark County, regardless of whether the discharge originates from developed or undeveloped lands, and regardless of whether the discharge is generated from an active construction site or a stabilized site. These discharges include flows from direct connections to the storm drain system, illegal dumping, and contaminated runoff.

Stormwater runoff from agricultural, timber harvesting, and mining activities is exempted from the requirements of this section unless determined to contain pollutants not associated with such activities or in excess of standard practices. Farm residences are *not* included in this exemption.

Any non-stormwater discharge permitted under an NPDES permit, waiver (unless the waiver is solely based on point source considerations, still allowing non-point source discharge of a pollutant), or waste discharge order issued to the discharger and administered under the authority of the Federal Environmental Protection Agency, provided that the discharger is in full compliance with all requirements of the permit, waiver, or order and other applicable laws and regulations, and provided that written approval has been granted for the subject discharge to the storm drain system, is also exempted from this section.

(b) PROHIBITED DISCHARGES AND CONNECTIONS

No person shall discharge to a MS4 conveyance, watercourse, or waterbody, directly or indirectly, any substance other than stormwater or an exempted discharge. Any person discharging stormwater shall effectively minimize pollutants from also being discharged with the stormwater, through the use of best management practices (BMP's).

Concrete washout material must be properly contained within an appropriate practice and any waste material properly disposed of.

The CCDB or its designee is authorized to require dischargers to implement pollution prevention measures, utilizing BMP's necessary to prevent or reduce the discharge of pollutants into the Clark County's stormwater drainage system.

(c) EXEMPTED DISCHARGES AND CONNECTIONS

Notwithstanding other requirements in this Ordinance, the following categories of non-stormwater discharges or flows are exempted from the requirements of this section:

- i. Water line flushing;
- ii. Landscape irrigation;
- iii. Diverted streamflows;
- iv. Rising ground waters;
- v. Uncontaminated groundwater infiltration;
- vi. Uncontaminated pumped ground water;
- vii. Discharges from potable water sources;
- viii. Foundation drains;
- ix. Air conditioning condensation;

- x. Irrigation water;
- xi. Springs;
- xii. Water from crawl space pumps;
- xiii. Footing drains;
- xiv. Lawn watering;
- xv. Individual residential car washing;
- xvi. Flows from riparian habitats and wetlands;
- xvii. Dechlorinated swimming pool discharges;
- xviii. Street wash water;
- xix. Discharges from firefighting activities;
- xx. Naturally introduced detritus (e.g. leaves and twigs).

(d) STORAGE OF HAZARDOUS OR TOXIC MATERIAL

Storage or stockpiling of hazardous or toxic material within any watercourse, or in its associated floodway or floodplain, is strictly prohibited. Storage or stockpiling of hazardous or toxic material, including sewage treatment plant stockpiles, on active construction sites must include adequate protection and/or containment so as to prevent any such materials from entering any temporary or permanent stormwater conveyance or watercourse.

(e) PRIVATE PROPERTY MAINTENANCE DUTIES

Every person owning property through which a watercourse passes, or such person's lessee, shall keep and maintain that part of the watercourse located within their property boundaries, free of trash, debris, excessive vegetation, and other obstacles that would pollute, contaminate, or significantly retard the flow of water through the watercourse. In addition, the owner or lessee shall maintain existing privately owned structures within or adjacent to a watercourse, so that such structures will not become a hazard to the use, function, or physical integrity of the watercourse.

(f) SPILL REPORTING

Any discharger who accidentally discharges into a waterbody any substance other than stormwater or an exempted discharge shall immediately inform the CCDB or its designee concerning the discharge. A written report concerning the discharge shall be filed with the CCDB or its designee and IDEM, by the dischargers, within five (5) days. The written report shall specify:

- i. The composition of the discharge and the cause thereof;
- ii. The date, time, and estimated volume of the discharge;
- iii. All measures taken to clean up the accidental discharge, and all measures proposed to be taken to prevent any recurrence;
- iv. The name and telephone number of the person making the report, and the name and telephone number of a person who may be contacted for additional information on the matter.

A properly reported accidental discharge shall be an affirmative defense to a civil infraction proceeding brought under this Ordinance against a discharger for such discharge. It shall not, however, be a defense to a legal action brought to obtain an injunction, to obtain recovery of costs or to obtain other relief because of or arising out of the discharge. A discharge shall be considered properly reported only if the discharger complies with all the requirements of this section. This requirement does not relieve discharger from notifying other entities as required by state or federal regulations.

(g) INSPECTIONS AND MONITORING

1. Storm Drainage System

The CCDB or its designee has the authority to periodically inspect the portion of the storm drainage system under the Clark County's control, in an effort to detect and eliminate illicit connections and discharges into the system. This inspection will include a screening of discharges from outfalls connected to the system in order to determine if prohibited flows are being conveyed into the storm drainage system. It could also include spot testing of waters contained in the storm drainage system itself to detect the introduction of pollutants into the system by means other than a defined outfall, such as dumping or contaminated sheet runoff.

2. Potential Polluters

If, as a result of the storm drainage system inspection, a discharger is suspected of an illicit discharge, the CCDB or its designee may inspect and/or obtain stormwater samples from stormwater runoff facilities of the subject discharger, to determine compliance with the requirements of this Ordinance. Upon request, the discharger shall allow the CCDB or its designee's properly identified representative to enter upon the premises of the discharger at all hours necessary for the purposes of such inspection or sampling. The CCDB or its designee or its properly identified representative may place on the discharger's property the equipment or devices used for such sampling or inspection. Identified illicit connections or discharges shall be subject to enforcement action as described in Section 7 of this Ordinance.

3. New Development and Re-Development

Following the final completion of construction and the receipt of as-built drawings by the CCDB or its designee, the CCDB or its designee has the authority to inspect new development and re-development sites to verify that all on-site stormwater conveyances and connections to the storm drainage system are in compliance with this section.

SECTION 3

Stormwater Quantity Management

(a) APPLICABILITY AND EXEMPTIONS

The storage and controlled release of excess stormwater runoff shall be required for all new business, institutional developments, commercial and industrial developments, residential subdivisions, planned development, rural estate subdivisions, and any redevelopment or other new construction located within the Clark County. The CCDB or its designee, after thorough investigation and evaluation, may waive the requirement of controlled runoff for minor subdivisions and parcelization. Additional potential exemptions regarding the detention requirements are provided under Sub-section (b).

(b) POLICY ON STORMWATER QUANTITY MANAGEMENT

It is recognized that most streams and drainage channels serving the Clark County do not have sufficient capacity to receive and convey stormwater runoff resulting from continued urbanization. Accordingly, the storage and controlled release of excess stormwater runoff as well as compensation for loss of floodplain storage shall be required for all developments and redevelopments (as defined in Appendix A) located within the Clark County. Release rate requirements, downstream restriction considerations, acceptable outlet, adjoining property impact considerations, policy on dams and levees, policy on Fluvial Erosion Hazard corridors, and compensatory floodplain storage rates are detailed in the Clark County Stormwater Technical Standards.

Due to unknowns regarding the future development patterns and the associated proposed stormwater quantity management systems within a watershed, it is the policy of the CCDB or its designee to discourage direct release of runoff from a new development or redevelopment without providing detention. However, in rare circumstances, where a comprehensive watershed-wide hydrologic study or watershed plan of a major stream (not a "beat the peak" analysis) adopted by the CCDB or its designee substantiates the benefits of (or allows for) direct release for a proposed development located adjacent to a major stream, the detention requirements set in this Ordinance may be waived. Other special circumstances when such a waiver may be considered by CCDB or its designee include situations where the design of a regional pond has already taken into account the provision of direct release in certain areas in the watershed.

(c) CALCULATIONS AND DESIGN STANDARDS AND SPECIFICATIONS

The calculation methods as well as the type, sizing, and placement of all stormwater facilities shall meet the design criteria, standards, and specifications outlined in the Clark County Stormwater Technical Standards Manual. The methods and procedures in the Stormwater Technical Standards Manual are consistent with the policy stated above.

(d) DRAINAGE EASEMENT REQUIREMENTS

All stormwater systems, including detention or retention basins, conveyance systems, structures and appurtenances, located outside of the right-of-way shall be placed within a drainage easement. There shall be no trees or shrubs planted, nor any structures or fences erected in any drainage easement unless otherwise accepted by CCDB or its designee. Additional easement requirements along stormwater conveyance systems are contained in the Clark County Stormwater Technical Standards Manual. All drainage improvements performed relative to the conveyance of stormwater runoff and the perpetual maintenance thereof, within the latter easements, shall be the responsibility of the owner or homeowner association.

(e) PLACEMENT OF UTILITIES

No utility company may disturb existing storm drainage facilities without the consent of the CCDB or its designee, whose decision may be appealed to the Board of Commissioners of the Clark County. All existing drainage facilities shall have senior rights and damage to said facilities shall result in penalties as prescribed in Section 7 of this ordinance.

(f) INSPECTION, MAINTENANCE, RECORD KEEPING, AND REPORTING

After the approval of the Stormwater Management Permit by the CCDB or its designee and the commencement of construction activities, the CCDB or its designee has the authority to conduct inspections of the work being done to ensure full compliance with the provisions of this section, the Stormwater Technical Standards Manual, Design and Construction Standards, and the terms and conditions of the approved permit.

The CCDB or its designee also has the authority to perform long-term, post-construction inspection of all public or privately owned stormwater quantity facilities. The inspection will cover physical conditions, available storage capacity, and the operational condition of key facility elements. Stormwater quantity facilities shall be maintained in good condition, in accordance with the designed and approved performance specifications for the facilities, in addition to any prescribed Operation & Maintenance procedures, and shall not be subsequently altered, revised or replaced except as approved by the CCDB or its designee. If deficiencies are found during the inspection, the owner of the facility will be notified by the CCDB or its designee and will be required to take all necessary measures to correct such deficiencies. If the owner fails to correct the deficiencies within the allowed time period, as specified in the notification letter, the CCDB or its designee will undertake the work and collect from the owner using lien rights if necessary.

Assignment of responsibility for maintaining facilities serving more than one lot or holding shall be documented by appropriate covenants to property deeds, unless responsibility is formally accepted by a public body, and determined before the final stormwater permit is approved.

Stormwater conveyance facilities may be donated to the Clark County or other unit of government designated by the CCDB or its designee, for ownership and permanent maintenance providing the Clark County or other governmental unit is willing to accept responsibility.

SECTION 4

Stormwater Pollution Prevention for Construction Sites

(a) APPLICABILITY AND EXEMPTIONS

The CCDB or its designee will require a Stormwater Pollution Prevention Plan (SWPPP), which includes erosion and sediment control measures and materials handling procedures, to be submitted as part of a project's construction plans and specifications. Any project located within the corporate boundaries of the Clark County that includes clearing, grading, excavation or other land disturbing activities resulting in the disturbance of 10,000 square feet or more of total land area is subject to the requirements of this section. This includes both new development and re-development. This section also applies to disturbances of land that are part of a larger common plan of development or sale if the larger common plan will ultimately disturb 10,000 square feet or more of total land area. Section 4 (c) provides guidelines for calculating land disturbance. Projects meeting the coverage requirements of IDEM's CSGP shall also be in compliance with the requirements contained in that permit.

The requirements under this section do not apply to the following activities, provided other applicable state permits contain provisions requiring immediate implementation of soil erosion and sediment control measures:

- i. Landfills that have been issued a certification of closure under 329 IAC 10.
- ii. Coal mining activities permitted under IC 14-34.
- iii. Municipal solid waste landfills that are accepting waste pursuant to a permit issued by the Indiana Department of Environmental Management under 329 IAC 10 that contains equivalent stormwater requirements, including the expansion of landfill boundaries and construction of new cells either within or outside the original solid waste permit boundary.

For an individual lot where land disturbance is expected to be one (1) acre or more, the individual lot owner must complete their own notice of intent letter, apply for a stormwater permit from the CCDB or its designee, and ensure that a sufficient construction and stormwater pollution prevention plan is completed and submitted in accordance with Section 6 of this Ordinance, regardless of whether the individual lot is part of a larger permitted project site. For an individual lot where land disturbance is 10,000 square feet or more but less than one (1) acre, an Individual Lot Plot Plan Permit application is required prior to receiving a building permit. Details of the permitting process are contained in Section 6.

An individual lot with land disturbance less than 10,000 square feet, located within a larger permitted project site, is considered part of the larger permitted project site, and the individual lot operator must comply with the terms and conditions of the stormwater permit approved for the larger project site. The stormwater permit application for the larger project site must include detailed erosion and sediment control measures for individual lots. In addition, these individual lots are required to submit Individual Lot Plot Plan Permit applications prior to receiving a building permit. Details of the permitting process are contained in Section 6 and additional requirements for individual lots may be found in the Clark County Stormwater Technical Standards Manual.

It will be the responsibility of the project site owner to complete a stormwater permit application and ensure that a sufficient construction plan is completed and submitted to the CCDB or its designee in accordance with Section 6 of this Ordinance. It will be the responsibility of the project site owner to ensure compliance with this Ordinance during the construction activity and implementation of the construction plan, and to notify the CCDB or its designee upon completion of the project and stabilization of the site, requesting a termination inspection to be performed by the CCDB or its designee. However, all persons engaging in construction and land disturbing activities on a permitted project site meeting the applicability requirements must comply with the requirements of this section and this Ordinance.

(b) POLICY ON STORMWATER POLLUTION PREVENTION

Effective stormwater pollution prevention on construction sites is dependent on a combination of preventing movement of soil from its original position (erosion control), intercepting displaced soil prior to entering a waterbody (sediment control), and proper on-site materials handling.

For land disturbance of one (1) acre or more, the developer must submit to the CCDB or its designee, a SWPPP with detailed erosion and sediment control plans as well as a narrative describing materials handling and storage, and construction sequencing. The SWPPP and the project management log must be retained for at least three (3) years from the date the project permit is terminated. For land disturbances totaling 10,000 square feet or more but less than one (1) acre, appropriate erosion and sediment control measures that are consistent with the Clark County Stormwater Technical Standards Manual must be designed and shown on the plans.

The required IDEM general and implementation requirements that apply to all land-disturbing activities are contained in the Clark County Stormwater Technical Standards Manual.

(c) CALCULATIONS AND DESIGN STANDARDS AND SPECIFICATIONS

In calculating the total area of land disturbance, for the purposes of determining applicability of this section to a project, the following guidelines should be used:

- i. Off-site construction activities that provide services (for example, road extensions, sewer, water, offsite stockpiles, and other utilities) to a land disturbing project site, must be considered as a part of the total land disturbance calculation for the project site, when the activity is under the control of the project site owner.
- ii. To determine if multi-lot project sites are regulated by this section, the area of land disturbance shall be calculated by adding the total area of land disturbance for improvements, such as, roads, utilities, or common areas, and the expected total disturbance on each individual lot, as determined by the following:
 1. For a single-family residential project site where the lots are one-half (0.5) acre or more, one-half (0.5) acre of land disturbance must be used as the expected lot disturbance.
 2. For a single-family residential project site where the lots are less than one half (0.5) acre in size, the total lot must be calculated as being disturbed.
 3. To calculate lot disturbance on all other types of project sites, such as industrial and commercial projects project sites, a minimum of one (1) acre of land disturbance must be used as the expected lot disturbance, unless the lots are less than one (1) acre in size, in which case the total lot must be calculated as being disturbed.

The calculation methods as well as the type, sizing, and placement of all stormwater pollution prevention measures for construction sites shall meet the design criteria, standards, and specifications outlined in the Indiana Stormwater Quality Manual, the Clark County Stormwater Technical Standards Manual, and the product guidance/specifications of the manufacturer. The methods and procedures included in these two references are in keeping with the above stated policy and meet the requirements of the IDEM's CSGP. A Copy of the Indiana Stormwater Quality Manual may be obtained online through IDEM.

The design requirements that would apply to all land-disturbing activities and shall be considered in the selection, design, and implementation of all stormwater quality and management measures contained in the SWPPP are contained in the Clark County Stormwater Technical Standards Manual.

(d) INSPECTION, MAINTENANCE, RECORD KEEPING, AND REPORTING

Following approval of the Stormwater Management Permit or Individual Lot Plot Plan Permit by the CCDB or its designee and commencement of construction activities, the CCDB or its designee has the authority to conduct inspections of the site to ensure full compliance with the provisions of this section, the approved Stormwater Pollution Prevention Plan, the Indiana Stormwater Quality Manual, and the terms and conditions of the approved permit.

A self-monitoring program (SMP) must be implemented by the project site owner to ensure the stormwater pollution prevention plan is working effectively. A trained individual, acceptable to the CCDB or its designee, shall monitor and manage project construction and stormwater activities. Details regarding the required monitoring activities are contained in the Clark County Stormwater Technical Standards Manual.

The stormwater pollution prevention plan shall serve as a guideline for stormwater quality but should not be interpreted to be the only basis for implementation of stormwater quality measures for a project site. The project site owner is responsible for implementing, in accordance with this section, all measures necessary to adequately prevent polluted stormwater runoff. Recommendations by the trained individual for modified stormwater quality measures should be implemented.

SECTION 5

Stormwater Quality Management for Post-construction

(a) APPLICABILITY AND EXEMPTIONS

In addition to the requirements of Section 4, the stormwater pollution prevention plan, which is to be submitted to the CCDB or its designee as part of the Stormwater Management Permit application, must also include post-construction stormwater quality measures. These measures are incorporated as a permanent feature into the site plan and are left in place following completion of construction activities to continuously treat stormwater runoff from the stabilized site. Any project located within the corporate boundaries of the Clark County that includes clearing, grading, excavation, and other land disturbing activities, resulting in the disturbance of 10,000 square feet or more of total land area is subject to the requirements of this section. This includes both new development and re-development, and disturbances of land less than 10,000 square feet of total land area that are part of a larger common plan of development or sale if the larger common plan will ultimately disturb 10,000 square feet or more of total land area. In addition, regardless of the amount of disturbance, the CCDB or its designee reserves the right to require pre-treatment BMPs for proposed hot spot developments in accordance with provisions contained in the Clark County Stormwater Technical Standards Manual.

The requirements under this section do not apply to the following activities:

- i. construction activities associated with a single-family residential dwelling disturbing less than one (1) acre, when the dwelling is not part of a larger common plan of development or sale; or individual building lots within a larger permitted project.

The requirements under this section do not apply to the following activities, provided other applicable state permits contain provisions requiring immediate implementation of soil erosion control measures:

- i. Landfills that have been issued a certification of closure under 329 IAC 10.
- ii. Coal mining activities permitted under IC 14-34.
- iii. Municipal solid waste landfills that are accepting waste pursuant to a permit issued by the Indiana Department of Environmental Management under 329 IAC 10 that contains equivalent stormwater requirements, including the expansion of landfill boundaries and construction of new cells either within or outside the original solid waste permit boundary.

It will be the responsibility of the project site owner to complete a stormwater permit application and ensure that a sufficient construction plan is completed and submitted to the CCDB or its designee in accordance with Section 6 of this Ordinance. It will be the responsibility of the project site owner to ensure proper construction and installation of all stormwater BMP's (especially, the protection of post-stormwater BMPs during construction phase) in compliance with this Ordinance and with the approved Stormwater Management Permit, and to notify the CCDB or its designee upon completion of the project and stabilization of the site, requesting a termination inspection to be performed by the CCDB or its designee. However, all eventual property owners of stormwater quality facilities meeting the applicability requirements must comply with the requirements of this section and this Ordinance.

(b) POLICY ON STORMWATER QUALITY MANAGEMENT

It is recognized that developed areas, as compared to undeveloped areas, generally have increased imperviousness, decreased infiltration rates, increased runoff rates, and increased concentrations of pollutants such as fertilizers, herbicides, greases, oil, salts and other pollutants. As new development and re-development continues within the corporate boundaries of the Clark County, measures must be taken to

intercept and filter pollutants from stormwater runoff prior to reaching regional creeks, streams, and rivers. Through the use of appropriate Best Management Practices (BMP's), stormwater runoff will be filtered and harmful amounts of sediment, nutrients, and contaminants will be removed.

It is also recognized that another major source of pollution in many Indiana streams, including those within the corporate boundaries of the Clark County, is the streambank erosion associated with urbanizing watersheds. Stream channels develop their shape in response to the volume and rate of runoff that they receive from their contributing watersheds. Research has shown that in hydrologically stable watersheds, the stream flow responsible for most of the shaping of the channel (called the bankfull flow) occurs between every one to two years. When land is developed, the volume and rate of runoff from that land increases for these comparatively small flooding events that are not normally addressed by the detention practices and the stream channel will adapt by changing its shape. As the stream channel works to reach a new stable shape, excess erosion occurs. As new development and re-development continues within the corporate boundaries of the Clark County, measures must be taken to minimize the impact of such development or re-development on streambank erosion. Through the use of appropriate Best Management Practices (BMP's), the volume and rate of runoff for channel forming flows will be reduced in an attempt to minimize increased streambank erosion in the receiving streams and channels.

The project site owner must submit to the CCDB or its designee a Stormwater Pollution Prevention Plan (SWPPP) that shows placement of appropriate BMP(s) from a pre-approved list of BMP's specified in the Clark County Stormwater Technical Standards Manual. The SWPPP submittal shall include an Operation and Maintenance Manual for all post-construction BMP(s) included in the project and a notarized Maintenance Agreement, consistent with the sample agreement provided in the Clark County Stormwater Technical Standards Manual, providing for the long-term maintenance of those BMPs, both of which shall be recorded with the deed for the property on which the project is located. The noted BMP(s) must be designed, constructed, and maintained according to guidelines provided or referenced in the Clark County Stormwater Technical Standards Manual. Practices other than those specified in the pre-approved list may be utilized. However, the burden of proof, as to whether the performance and ease of maintenance of such practices will be according to guidelines provided in the Clark County Stormwater Technical Standards Manual, would be placed with the applicant. Details regarding the procedures and criteria for consideration of acceptance of such BMP's are provided in the Clark County Stormwater Technical Standards Manual.

Gasoline outlets and refueling areas must install appropriate practices to reduce lead, copper, zinc, and polyaromatic hydrocarbons in stormwater runoff. These requirements will apply to all new facilities and existing facilities that replace their tanks, regardless of the size of the facility.

Discharges from new development and redevelopment sites will not be allowed directly into karst features without pre-treatment.

(c) CALCULATIONS AND DESIGN STANDARDS AND SPECIFICATIONS

Calculation of land disturbance should follow the guidelines discussed in Section 3(c).

The calculation methods as well as the type, sizing, and placement of all stormwater quality management measures, or BMPs shall meet the design criteria, standards, and specifications outlined in the Clark County Stormwater Technical Standards Manual. The methods and procedures included in the referenced Standards is in keeping with the above stated policy and meet or exceed the requirements of IDEM's MS4 GP.

(d) EASEMENT REQUIREMENTS

All stormwater quality management systems, including detention or retention basins, filter strips, pocket wetlands, in-line filters, infiltration systems, conveyance systems, structures and appurtenances located

outside of the right-of-way shall be incorporated into permanent easements. For the purposes of monitoring, inspection, and general maintenance activities, adequate easement width, as detailed in the Clark County Stormwater Technical Standards Manual, beyond the actual footprint of the stormwater quality management facility as well as a 20-foot wide access easement from a public right-of-way to each BMP shall be provided.

(e) INSPECTION, MAINTENANCE, RECORD KEEPING, AND REPORTING

After the approval of the Stormwater Management Permit by the CCDB or its designee and the commencement of construction activities, the CCDB or its designee has the authority to conduct inspections of the work being done to ensure full compliance with the provisions of this section, the approved Stormwater Pollution Prevention Plan, the Clark County Stormwater Technical Standards Manual, and the terms and conditions of the approved permit.

Stormwater quality facilities shall be maintained in good condition, in accordance with the Operation and Maintenance procedures and schedules listed in the Clark County Stormwater Technical Standards Manual, in addition to the designed and approved performance specifications for the facilities and shall not be subsequently altered, revised, or replaced except as approved by the CCDB or its designee.

Details regarding the required of stormwater BMP Maintenance Agreement, O&M Maintenance Manual, and a Maintenance Escrow account and their transfer to other parties or subsequent owners prior to release of the maintenance bond discussed in Section 6 of this Ordinance is provided in the Clark County Stormwater Technical Standards Manual.

The CCDB or its designee also has the authority to perform long-term, post-construction inspection of all public or privately owned stormwater quality facilities. The inspection will cover physical conditions, available water quality storage capacity and the operational condition of key facility elements. Noted deficiencies and recommended corrective action will be included in an inspection report.

SECTION 6

Permit Requirements and Procedures

(a) CONCEPTUAL DRAINAGE PLAN REVIEW

In order to gain an understanding of the drainage requirements for a specific project, a developer may submit conceptual drainage plans and calculations for review by the CCDB or its designee. The direction provided by the CCDB or its designee during such a review is based on preliminary data and shall not be construed as an acceptance or binding on either party. The following is a general listing of minimum data requirements for the review of conceptual drainage plans:

- i. Two (2) complete sets of conceptual plans showing general project layout, including existing and proposed drainage systems (plan sheets must be larger than 11" by 17", but not to exceed 24" by 36").
- ii. General description of the existing and proposed drainage systems in narrative form.
- iii. Map showing on-site 100-year floodplain and floodway (please note if none exists).
- iv. Map showing all wetlands, lakes, and ponds on or adjacent to the site.
- v. Watershed Boundaries with USGS Contours or best information possible.
- vi. Two (2) copies of drainage calculations detailing existing and proposed discharges from the site
- vii. Existing watercourse or drains.

(b) PERMIT PROCEDURES

This section applies to all development, or re-development of land, that results in land disturbance of one (1) acre or more. Individual lots with land disturbance less than one (1) acre shall refer to Sections 4 and 5 and subsection (d) below for plan review requirements and procedures. Figure 1 is a flowchart summarizing the plan review/permit approval/project termination compliance process for land disturbance of one (1) acre or more and can be found at the end of this section.

1. General Procedures

The project site owner shall submit an application for a Stormwater Management Permit to the CCDB or its designee. The application will include a completed application checklist, construction plan sheets, a stormwater drainage technical report, a stormwater pollution prevention plan, and any other necessary support information. Specific information to be included in the application can be found in Subsection (c) below. xx copies of each application must be submitted to the CCDB or its designee. The CCDB or its designee may, at its discretion, require one or more copies be submitted to other entities deemed appropriate by the CCDB or its designee. Additionally, a digital copy of the construction plans is required in a format accepted by the CCDB or its designee.

After the CCDB or its designee's receipt of the application, the applicant will be notified as to whether their application was complete or insufficient. The applicant will be asked for additional information if the application is insufficient. If the application is complete, it will be reviewed in detail by the CCDB or its designee and/or its plan review consultant(s). Once all comments have been received and review completed, the CCDB or its designee will either approve the project, request modifications or deny the project. If the applicant does not agree with or accept the review findings and wishes to seek an appeal, the CCDB or its designee will place the project on the agenda of the next regularly scheduled meeting of the Clark County Drainage Board, provided the agenda for the meeting has not yet been advertised or published. If time for notification does not allow, the project shall be placed on the following regularly scheduled meeting of the Clark County Drainage Board. If the project must go through a scheduled meeting, the CCDB or its designee will furnish the applicant a complete list of comments and objections to the plans and accompanying data prior to the scheduled meeting. After the scheduled meeting, the

CCDB or its designee will either issue a permit, request modifications to the construction plans, or deny the project.

The project site owner must notify the CCDB or its designee and IDEM before beginning construction. Notification to the CCDB or its designee shall be in the form of an email while the notification to IDEM shall be in the form of an online IDEM NOI submittal. Once a permit has been issued and the pending construction notifications submitted to the CCDB or its designee and IDEM before the beginning of construction, construction may commence. Once construction starts, the project owner shall monitor construction activities and inspect all stormwater pollution prevention measures in compliance with this Ordinance and the terms and conditions of the approved permit. Upon completion of construction activities, a Certification of Completion and Compliance and as-built plans must be submitted to the CCDB or its designee. Once the construction site has been stabilized and all temporary erosion and sediment control measures have been removed, a notification shall be sent to the CCDB or its designee, *requesting a termination inspection*. The CCDB or its designee, or its representative, shall inspect the construction site to verify that the completed project is fully stabilized and meets the requirements of Clark County's stormwater Ordinance and its technical standards and that the terms and conditions of the permit. Once the applicant receives a signed copy of the Termination Inspection Checklist confirming compliance, they must forward a copy to IDEM along with the required IDEM NOT form. Permits issued by the CCDB or its designee under this scenario will expire 5 years from the date of issuance. If construction is not completed within 5 years, an updated permit application must be submitted to the CCDB or its designee and an updated NOI must be resubmitted to IDEM at least 90 days prior to expiration.

2. SWPPP Review Time Limits

Pursuant to IC 13-18-27, an MS4-designated entity or other review authority such as SWCD must make a preliminary determination as to whether the construction plan associated with SWPPP is substantially complete before the end of the tenth (10th) working day after the day on which the construction plan associated with SWPPP is submitted to the review authority, in the case of a less than 5 acres construction activity site or the fourteenth (14th) working day after the day on which the construction plan associated with SWPPP is submitted to the review authority, in the case of a 5 acres or larger construction activity site. Depending on the outcome of the SWPPP review, the following scenarios may play out:

- a. No SWPPP review notification received: If the review authority does not notify of its preliminary determination as to whether the construction plan is substantially complete within either 10 or 14 days as noted above, the project site owner may submit a notice of intent letter to IDEM including the information required by IDEM, or this Ordinance and the Clark County Stormwater Technical Standards Manual, and after submission of the notice of intent letter to IDEM, may begin the construction project, including the land disturbing activities of the construction project.
- b. SWPPP not substantially complete: If the review authority notifies the construction plan is not substantially complete, the project site owner may not submit a notice of intent letter to IDEM until the review authority makes a conclusive favorable determination concerning the construction plan under the IDEM rule/permit, or this Ordinance and the Clark County Stormwater Technical Standards Manual.
- c. Unfavorable SWPPP: If the review authority notifies the construction plan is substantially complete; and makes a conclusive unfavorable determination concerning the construction plan under IDEM rule/permit, or this Ordinance and the Clark County Stormwater Technical Standards Manual; the land disturbing activities of the construction project must stop when the review authority notifies the project site owner of the review authority's conclusive unfavorable determination concerning the construction plan.

Note that the above time limits only apply to the SWPPP portion of the overall stormwater permit submittal and does not affect any official or non-official permit review timelines set by the entity for other aspects of the stormwater permit application.

(c) INFORMATION REQUIREMENTS

Specific projects or activities may be exempt from all or part of the informational requirements listed below. Exemptions are detailed in the "Applicability and Exemptions" Sections of Sections 2 through 5. If a project or activity is exempt from any or all requirements of this ordinance, an application should be filed listing the exemption criteria met, in lieu of the information requirements listed below. This level of detailed information is not required from individual lots, disturbing less than 1 acre of land, developed within a larger permitted project site. Review and acceptance of such lots is covered under Section (d).

The different elements of a permit submittal include an application checklist, construction plans, a stormwater drainage technical report, a stormwater pollution prevention plan for active construction sites, a post-construction stormwater pollution prevention plan, and any other necessary supporting information. All plans, reports, calculations, and narratives shall be signed and sealed by a professional engineer or a licensed surveyor, registered in the State of Indiana who also meets the definition of a certified professional found in Appendix A.

1. Application Checklist

As part of the Clark County Stormwater Management Permit application package, the application checklist provided in the Clark County Stormwater Technical Standards Manual must be completed by the applicant and provided along with other required supporting material.

2. Construction Plans

Construction plan sheets (larger than 11" by 17", but not to exceed 24" by 36" in size) and an accompanying narrative report shall describe and depict the existing and proposed conditions. Note that in order to gain an understanding of and to evaluate the relationship between the proposed improvements for a specific project section/phase and the proposed improvements for an overall multi-section (phased) project, the detailed information requested herein for the first section/phase being permitted must be accompanied by an overall project plan that includes the location, dimensions, and supporting analyses of all detention/retention facilities, primary conveyance facilities, and outlet conditions. Construction plans must include items listed in the application checklist provided in the Clark County Stormwater Technical Standards Manual.

3. Stormwater Drainage Technical Report

A written stormwater drainage technical report must contain a discussion of the steps taken in the design of the stormwater drainage system. Note that in order to gain an understanding of and to evaluate the relationship between the proposed improvements for a specific project section/phase and the proposed improvements for an overall multi-section (phased) project, the detailed information requested herein for the first section/phase being permitted must be accompanied by an overall project plan that includes the location, dimensions, and supporting analyses of all detention/retention facilities, primary conveyance facilities, and outlet conditions. The technical report needs to include items listed in the application checklist provided in the Clark County Stormwater Technical Standards Manual.

4. Stormwater Pollution Prevention Plan for Construction Sites

For sites with total disturbance of one (1) acre or more, a stormwater pollution prevention plan associated with construction activities must be designed to, at least, meet the requirements of this Ordinance. The SWPPP and construction plans must include the items listed in the application checklist provided in the Clark County Stormwater Technical Standards Manual. For land disturbances totaling 10,000 square feet or more of land area but less than one (1) acre, appropriate erosion and sediment control measures that are consistent with the Clark County Technical Standards must be designed and shown on the plans.

5. Post-Construction Stormwater Pollution Prevention Plan

For sites with total land disturbance of 10,000 square feet or more of total land area, a post-construction stormwater pollution prevention plan must be designed to, at least, meet the requirements of this Ordinance

and must include the information provided in the Clark County Stormwater Technical Standards Manual. The post-construction stormwater pollution prevention plan must include items listed in the application checklist provided in the Clark County Stormwater Technical Standards Manual.

(d) REVIEW OF INDIVIDUAL LOTS

For all individual lots disturbing 10,000 square feet or more but less than one (1) acre, a formal review and issuance of an Individual Lot Plot Plan Permit will be required before a building permit can be issued. Similarly, for individual lots disturbing less than 10,000 square feet of total land area, developed within a larger permitted project, a formal review and issuance of an Individual Lot Plot Plan Permit will be required before a building permit can be issued. All stormwater management measures necessary to comply with this Ordinance must be implemented in accordance with permitted plan for the larger project.

The following information must be submitted to the CCDB or its designee, for review and acceptance, by the individual lot operator, whether owning the property or acting as the agent of the property owner, as part of a request for review and issuance of an Individual Lot Plot Plan Permit that must be obtained prior to the issuance of a building permit.

- I. A site layout for the subject lot and all adjacent lots showing building pad location, dimensions, and elevations, and the drainage patterns and swales.
- II. Erosion and sediment control plan that, at a minimum, includes the following measures:
 1. Installation and maintenance of a stable construction site access.
 2. Installation and maintenance of appropriate perimeter erosion and sediment control measures prior to land disturbance.
 3. Minimization of sediment discharge and tracking from the lot.
 4. Clean-up of sediment that is either tracked or washed onto roads. Bulk clearing of sediment shall not include flushing the area with water. Cleared sediment must be redistributed or disposed of in a manner that is in compliance with all applicable statutes and rules.
 5. Implementation of concrete washout practices that securely contain and allow for the proper disposal of washout waste.
 6. Adjacent lots disturbed by an individual lot operator must be repaired and stabilized with temporary or permanent surface stabilization.
 7. Self-monitoring program including plan and procedures.

Certification of Compliance stating that the individual lot plan is consistent with the Stormwater Management Permit, as approved by the CCDB or its designee, for the larger project (if the individual lot is part of a larger permitted project).

Name, address, telephone number, and list of qualifications of the trained individual in charge of the mandatory stormwater pollution prevention self-monitoring program for the project site.

The individual lot operator is responsible for installation and maintenance of all erosion and sediment control measures until the site is stabilized.

(e) CHANGES TO PLANS

Any changes or deviations in the detailed plans and specifications after approval of the applicable Stormwater Management Permit shall be filed with, and accepted by, the CCDB or its designee prior to the land development involving the change. Copies of the changes, if accepted, shall be attached to the original plans and specifications.

(f) FEE STRUCTURE

1. FEE AMOUNT

As a condition of the submittal and the review of development plans by the CCDB or its designee, the applicant shall agree to pay the CCDB or its designee the applicable fee, as set by the CCDB or its designee with respect to the review of all drainage submittals, preliminary plans, final plans, construction plans and accompanying information and data, as well as prepaid inspection fees.

2. TIME OF PAYMENT

After the meeting at which the CCDB or its designee is scheduled to consider acceptance of the applicant's final stormwater management plan, the CCDB or its designee will furnish a written statement to the applicant specifying the total amount due the CCDB or its designee in connection with the review of the applicant's submittals, plans and accompanying information and data, including the amount required to be paid by applicant for review and pre-paid inspection fees.

As a condition of acceptance of final drainage plans by the CCDB or its designee, applicant shall pay to the CCDB or its designee the sum set forth in said statement. The CCDB or its designee may issue such a billing statement before the project advances to the final acceptance stage, and such payment is due by applicant upon receipt of said billing statement regardless of whether the project is advanced to the final acceptance stage.

The CCDB or its designee shall have the right to not accept the drainage improvements or to not approve the advancement of any project for which the applicable fees have not been paid.

3. METHOD OF PAYMENT

Fees shall be paid by one of the following methods:

- Check
- Certified Check
- Cashier's Check
- Money Order

All checks shall be made payable to the: *Jurisdiction Entity's Address*

4. REFUND OF PAYMENT

Fees are refundable **only** if the CCDB or its designee determines that compliance by the development or project to this Ordinance is not necessary.

5. FEE SCHEDULE

Stormwater Permit Application and Inspection Fees will be in accordance with the fee schedule set by CCDB or its designee as a separate resolution.

(g) REQUIRED ASSURANCES

This section shall apply to all projects whether the stormwater management system or portions thereof will be dedicated to the CCDB or its designee or retained privately. As a condition of approval and issuance of the permit, the CCDB or its designee shall require the applicant to provide assurance in form of an irrevocable letter of credit or a bond when the stormwater management plan has been accepted and before construction begins. Said assurance will guarantee a good faith execution of the stormwater drainage plan, the stormwater pollution prevention plan, the stormwater quality management plan, and any permit conditions. The assurance shall be for an amount equal to 125 percent of the total costs of all stormwater management measures for the entire project. The above-mentioned costs shall be based on an estimate as prepared by a registered engineer or land surveyor. Said costs shall be for the installation and ongoing monitoring and

maintenance of erosion control measures and the construction and ongoing monitoring and maintenance of storm drainage infrastructure, detention/retention facilities, and stormwater quality BMP's, as regulated under this Ordinance, until the construction is completed, the site is stabilized, and as-built plans are accepted by the CCDB or its designee. Assurances shall be for a minimum of \$5,000. All other performance bonds, maintenance bonds or other assurances required by the CCDB or its designee in accordance with any and all other ordinances shall also apply and so be required. Local governmental jurisdictions may require additional performance and/or maintenance assurances. The intent of this assurance is not only to complete the installation of storm drain infrastructure for the project, but also to assure that adequate stormwater pollution prevention measures are properly installed and maintained. If adequate assurances are set aside by the project site owner for the overall project, proof of total assurance can be submitted in place of an individual stormwater assurance.

(h) TERMS AND CONDITIONS OF PERMITS

In granting a Stormwater Management Permit, the CCDB or its designee may impose such terms and conditions as are reasonably necessary to meet the purposes of this Ordinance. The project site owner shall insure compliance with such terms and conditions. Non-compliance with the terms and conditions of permits will be subject to enforcement as described in Section 7.

The project site owner shall inform all general contractor, construction management firms, grading or excavating contractors, utility contractors, and the contractors that have primary oversight on individual building lots of the terms and conditions of the Stormwater Management Permit and the schedule for proposed implementation.

In the event that a project site is determined to impact or discharge to a Sensitive Area or is located in an Impact Drainage Area, the CCDB or its designee may require more stringent stormwater quantity and quality measures than detailed in this Ordinance or in the *Indiana Stormwater Quality Manual*.

1. Determination of Sensitive Areas

Sensitive Areas include highly erodible soils, wetlands, karst areas, threatened or endangered species habitat, outstanding waters, impaired waters, recreational waters, and surface drinking water sources. Any discharge from a stormwater practice that is a Class V injection well shall meet the Indiana groundwater quality standards and registered with US EPA as required by the IDEM. If wetlands are suspected on a site, a wetland delineation should be completed in accordance with the methodology established by the U.S. Army Corps of Engineers (COE). The need for the applicant to check for the presence of threatened or endangered species habitat will be determined on a case-by-case basis. Special terms and conditions for development determined to impact or discharge to any Sensitive Area shall be included in the Stormwater Management Permit.

2. Determination of Impact Drainage Areas

The following areas shall be designated as Impact Drainage Areas, unless good reason for not including them is presented to the CCDB or its designee.

- i. A floodway or floodplain as designated by the most updated FEMA Code dealing with floodplain regulation and/or by the Best Available Data through IDNR.
- ii. Land within 25 feet of each bank of any ditch within the Clark County's system.
- iii. Land within 15 feet of the centerline of any stormwater infrastructure or enclosed conduit within the Clark County's system.
- iv. Land within 50 feet of a natural drainageway.
- v. Land within the Fluvial Erosion Hazard (FEH) corridor.
- vi. Land within the expected breach inundation zone of an existing or proposed new dam, and areas protected from flooding by a levee.

The CCDB or its designee or Clark County Engineer is authorized, but is not required, to classify certain geographical areas as Impact Drainage Areas. In determining Impact Drainage Areas, the CCDB or its designee may consider such factors as topography, soil type, capacity of existing drains, and distance from adequate drainage facility.

Land that does not have an adequate outlet, taking into consideration the capacity and depth of the outlet, may be designated as an Impact Drainage Area by the CCDB or its designee. Special terms and conditions for development within any Impact Drainage Area shall be included in the Stormwater Management Permit.

3. Determination of Designated Drainage Areas Served by Regional Facilities

The CCDB or its designee is authorized, but is not required, to classify certain geographical areas as Designated Drainage Areas that are or will be served by regional facilities, such as a regional pond. In such cases, an Infrastructure Development Fee (IDF) rate may be established for the Designated Drainage Area. The basis for determining such a fee for a proposed development or re-development within a Designated Drainage Area will be as detailed in the Clark County Stormwater Technical Standards Manual.

(i) CERTIFICATION OF AS-BUILT PLANS

This section shall apply to all projects whether the stormwater management system or portions thereof will be dedicated to the CCDB or its designee or retained privately. After completion of construction of the project and before the release of required performance assurances referenced in Section (g) above, a professionally prepared and certified 'as-built' set of plans (record drawings) shall be submitted to the CCDB or its designee for review. These as-built plans/record drawings must be prepared and certified by the Engineer of Record, i.e., the company/engineer who originally prepared the construction plans. Additionally, a digital copy of the 'as-built' plans (record drawings) as well as finalized digital versions of all analyses, models, manuals, and reports that are consistent with the as-built conditions is required in a format acceptable to the CCDB or its designee. These plans shall include all pertinent data relevant to the completed storm drainage system and stormwater management facilities, and shall include:

1. Pipe size and pipe material
2. Invert elevations
3. Top rim elevations
4. Elevation of the emergency overflow (spillway) for ponds
5. Grades along the emergency flood routing path(s)
6. Pipe structure lengths
7. BMP types, dimensions, and boundaries/easements
8. "As-planted" plans for BMP's, as applicable
9. Data and calculations showing detention basin storage volume
10. Data and calculations showing BMP treatment capacity
11. Certified statement on plans stating the completed storm drainage system and stormwater management facilities substantially comply with construction plans and the Stormwater Management Permit as approved by the CCDB or its designee. (See certificate in the Stormwater Technical Standards Manual.

(j) POST-PROJECT MAINTENANCE BOND AND VERIFICATIONS

In addition to as-built plans and the certification of completion and compliance, following the release of performance assurances, the property owner, developer, or contractor shall be required to file a two-year maintenance bond or other acceptable guarantee with the CCDB or its designee in an amount not to exceed twenty five percent (25%) of the cost of the stormwater management system located outside the public road rights-of-way, and in a form satisfactory to the CCDB or its designee in order to assure that such stormwater system installation was done according to standards of good workmanship, that the materials used in the

construction and installation were of good quality and construction, and that such project was done in accordance with the accepted plans, and this Ordinance and that any off-site drainage problems that may arise, whether upstream or downstream of such project, will be corrected if such drainage problems are determined by CCDB or its designee to have been caused by the development of such project. The bond or other acceptable guarantee shall be in effect for a period of two years after the date of the release of required performance assurances referenced in Section (g) above. The beneficiary of all maintenance bonds shall be the Clark County Council.

To verify that all stormwater infrastructure is functioning properly, visual recordings (via closed circuit television) of such infrastructure, including all subsurface drains, shall be required twice, once following the completion of installation of the stormwater management system and submittal of as-builts, and the second time before release of maintenance bonds. These visual recordings will be scheduled by the CCDB or its designee and paid for by the developer. Notices shall be provided to the CCDB or its designee within 72 hours following the completion of installation and again at least 60 days prior to the expiration date of the maintenance bond so that the noted recordings may be scheduled. Reports summarizing the results of the noted visual recordings shall be reviewed and accepted by the CCDB or its designee before the plat is recommended for recording and again before the maintenance bond shall be recommended to be released.

Additional requirements for transfer of any applicable stormwater BMP Maintenance Agreement, O&M Maintenance Manual, and Maintenance Escrow accounts to subsequent owners prior to release of the maintenance bond is discussed in Section 5 of this ordinance.

Figure 1: Permit Approval and Project Termination Sign-off Process

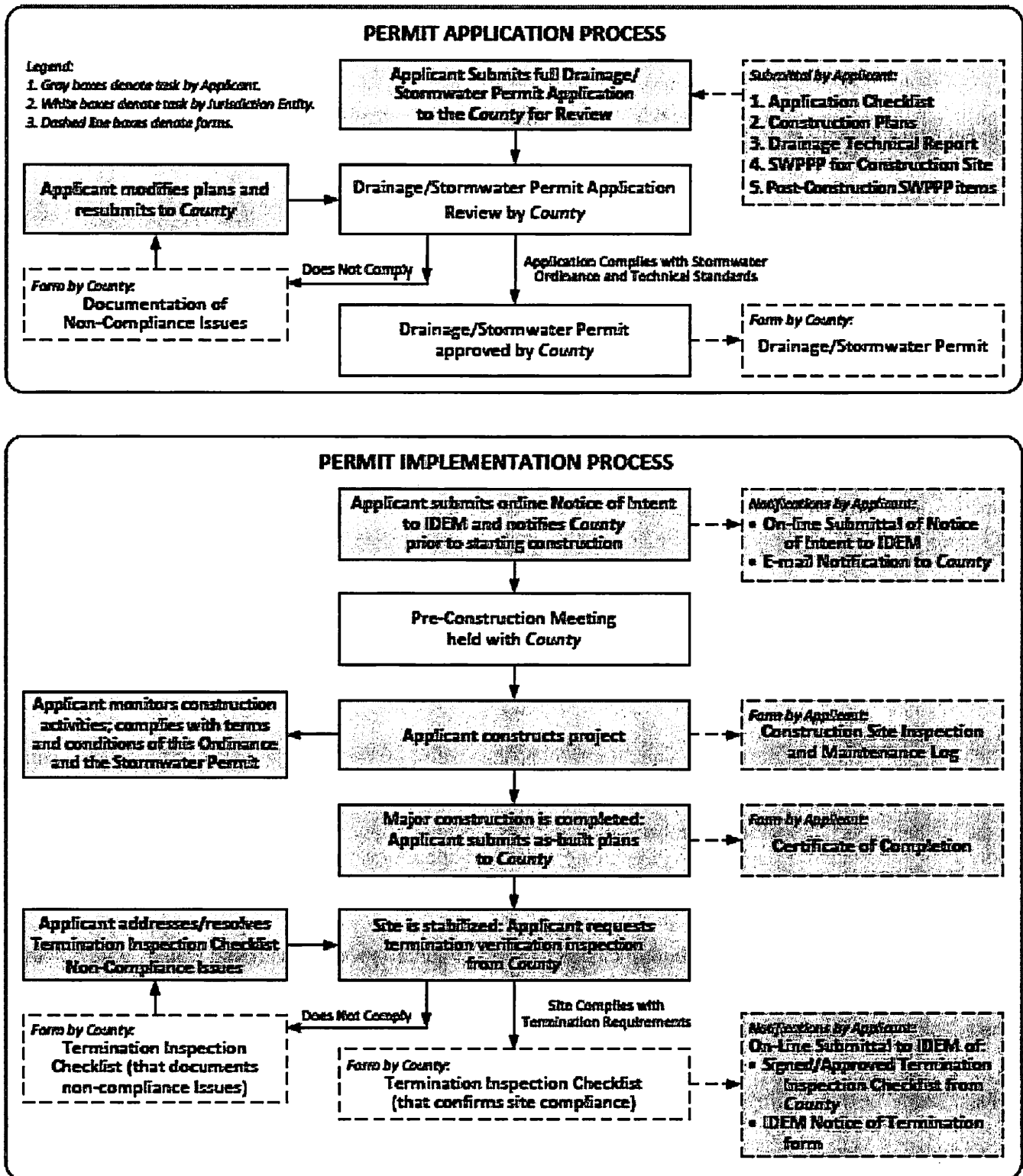

SECTION 7

Compliance and Enforcement

(a) COMPLIANCE WITH THIS ORDINANCE

In addition to the requirements of this Ordinance, compliance with the requirements set forth in the local Zoning Ordinances is also necessary. Compliance with all applicable ordinances of the Clark County as well as with applicable State of Indiana statutes and regulations shall also be required. Unless otherwise stated, all other specifications referred to in this Ordinance shall be the most recent edition available. Violations of the requirements of this Ordinance are subject to the penalties listed below.

1. Violations

Any action or inaction which violates the provisions of this Ordinance, the requirements of an approved stormwater management design plan or permit, and/or the requirements of a recorded stormwater maintenance agreement may be subject to the enforcement actions outlined in this Section. Any such action or inaction is deemed to be a public nuisance and may be abated by injunctive or other equitable relief. The imposition of any of the penalties described below shall not prevent such equitable relief.

2. Warning Notice

When the CCDB or its designee finds that any person has violated, or continues to violate, any provision of this ordinance, or any order issued hereunder, the CCDB or its designee may serve upon that person a written Warning Notice, specifying the particular violation believed to have occurred and requesting the discharger to immediately investigate the matter and to seek a resolution whereby any offending discharge will cease. Investigation and/or resolution of the matter in response to the Warning Notice in no way relieves the alleged violator of liability for any violations occurring before or after receipt of the Warning Notice. Nothing in this subsection shall limit the authority of the CCDB or its designee to take any action, including emergency action or any other enforcement action, without first issuing a Warning Notice.

(b) ENFORCEMENT OF THIS ORDINANCE

1. Notice of Violation/Citation

If the CCDB or its designee determines that an applicant or other responsible person has failed to comply with the terms and conditions of a permit, an approved stormwater management design plan, a recorded stormwater management maintenance agreement, or the provisions of this ordinance, it shall issue a written Notice of Violation to such applicant or other responsible person and the owner of the property. Where a person is engaged in activity covered by this ordinance without having first secured a permit therefore, the notice of violation shall be served on the owner or the responsible person in charge of the activity being conducted on the site.

The notice of violation can be in the form of a citation ticket and/or a written letter that would contain detailed inspection findings, conclusions of law, disposition of warning or fines assessed, stipulated remedial actions as discussed with the responsible party representative, reasonable deadlines for those remedial actions, and the date of re-inspection.

2. Compensatory Action

In lieu of enforcement proceedings, penalties, and remedies authorized by this ordinance, the CCDB or its designee may impose upon a violator, alternative compensatory actions, such as storm drain stenciling, attendance at compliance workshops, creek cleanup, public education, etc.

3. Civil Penalties for Violations

Any person found in violation of any provision of this Ordinance shall be responsible for a civil infraction and subject to a maximum fine of \$2,500 for each offense, plus costs, damages, and expenses. Each day such

violation occurs or continues shall be deemed a separate offense and shall make the violator liable for the imposition of a fine for each day. The rights and remedies provided for in this section are cumulative and in addition to any other remedies provided by law. An admission or determination of responsibility shall not exempt the offender from compliance with the requirements of this Ordinance.

Any person who aids or abets a person in a violation of this Ordinance shall be subject to the penalties provided in this section.

For purposes of this section, "subsequent offense" means a violation of the provisions of this Ordinance committed by the same person within 12 months of a previous violation of the same provision of this Ordinance for which said person admitted responsibility or was adjudicated to be responsible.

The CCDB or its designee has established an Enforcement Response Schedule that standardizes the approach the CCDB or its designee may take in dealing with stormwater regulations offenses subject to this Ordinance and the associated Technical Standards document. The enforcement response schedule is as noted in the following table:

Offence #	Type of Response/Anticipated
1 st offense	Verbal Telephone Notice, Letter of Violation or Written Warning and Administrative Penalty
2 nd offense	Letter of Violation, Administrative Penalty and/or Site Visit
3 rd offense	Letter of Violation, Administrative Penalty and/or Site Visit
4 th offense	Letter of Violation, Administrative Penalty and/or Site Visit
5 th offense	Agreed Order, Administrative Penalty and/or Site Visit
6 th offense	Administrative Order, Administrative Penalty and/or Site Visit
7 th offense	Compliance Schedule, Administrative Penalty and/or Site Visit
8 th offense	Litigation and Administrative Penalty

The Administrative Penalties shall be assessed on a per violation, per offense basis. The schedule of penalties is summarized in the following table:

Offence #	Penalty
1 st offense	\$250.00
2 nd offense	\$500.00
3 rd offense	\$1,000.00
4 th offense	\$2,500.00

The CCDB or its designee reserves the right to issue a maximum fine for any violation deemed sufficiently egregious or otherwise determined by the CCDB or its designee to warrant a maximum penalty.

4. Stop Work Order

In addition to the penalties listed above, if land disturbance activities are conducted contrary to the provisions of this Ordinance or accepted final stormwater management plans, the CCDB or its designee may order the work stopped by notice in writing served on any person engaged in the doing or causing of such work to be done, and any such persons shall forthwith stop such work until authorized by the CCDB or its designee to proceed with the work. A Stop Work Order will be posted on the site by the CCDB or its designee and it is unlawful for any person to remove the notice or continue any work on the site without permission from the CCDB or its designee. The CCDB or its designee may also undertake or cause to be undertaken, any necessary or advisable protective measures to prevent violations of this Ordinance or to avoid or reduce the effects of noncompliance herewith. The cost of any such protective measures shall be the responsibility of the owner of the property upon which the work is being done and the responsibility of any person carrying out or participating in the work.

Any person who neglects or fails to comply with a stop work order shall, upon conviction, be guilty of a misdemeanor, punishable by a fine of not less than \$1,000, and such person shall also pay such costs as

may be imposed in the discretion of the court. A permit reinstatement fee may also be assessed by the CCDB or its designee.

For construction projects that are operating under a SWPPP approved by the CCDB or its designee, if a Stop Work Order is issued on the grounds that the erosion and sediment control measures included in the construction plan are not adequate, the project site owner must be notified in writing of the inadequacies in the erosion and sediment control measures and the project site owner has seventy-two (72) hours after receiving written notice to resolve the identified inadequacies before the Stop Work Order can take effect.

The seventy-two (72) hour period to resolve identified inadequacies on a construction project does not apply if the Stop Work Order is issued to a construction project where the project site owner is creating a public health hazard or safety hazard.

5. Withhold Certificate of Occupancy

The CCDB or its designee may refuse to issue a certificate of occupancy for the building or other improvements constructed or being constructed on the site until the applicant or other responsible person has taken the remedial measures set forth in the notice of violation or has otherwise satisfied the requirements of this ordinance as determined by the CCDB or its designee.

6. Suspension, Revocation, or Modification of Permits

The CCDB or its designee may suspend, revoke, or modify any existing permit that the violator may also have been previously granted. A suspended, revoked, or modified permit may be reinstated after the applicant or other responsible person has taken the remedial measures set forth in the notice of violation or has otherwise cured the violations described therein, provided such permit may be reinstated upon such conditions as the CCDB or its designee may deem necessary to enable the applicant or other responsible person to take the necessary remedial measures to cure such violations.

7. Suspension of Access to the Stormwater Drainage System

i. Emergency Cease and Desist Orders

When the CCDB or its designee finds that any person has violated, or continues to violate, any provision of this ordinance, or any order issued hereunder, or that the person's past violations are likely to recur, and that the person's violation(s) has (have) caused or contributed to an actual or threatened discharge to the MS4 or waters of the United States which reasonably appears to present an imminent or substantial endangerment to the health or welfare of persons or to the environment, the CCDB or its designee may issue an order to the violator directing it immediately to cease and desist all such violations and directing the violator to immediately comply with all ordinance requirements and take such appropriate preventive action as may be needed to properly address a continuing or threatened violation, including immediately halting operations and/or terminating the discharge.

Any person notified of an emergency order directed to it under this Subsection shall immediately comply and stop or eliminate its endangering discharge. In the event of a discharger's failure to immediately comply voluntarily with the emergency order, the CCDB or its designee may take such steps as deemed necessary to prevent or minimize harm to the stormwater drainage system or waters of the United States, and/or endangerment to persons or to the environment, including immediate termination of a facility's water supply, sewer connection, or other municipal utility services.

The CCDB or its designee may allow the person to recommence its discharge when it has demonstrated to the satisfaction of the CCDB or its designee that the period of endangerment has passed, unless further termination proceedings are initiated against the discharger under this ordinance. A person that is responsible, in whole or in part, for any discharge presenting imminent endangerment shall submit a detailed written statement, describing the causes of the harmful discharge and the measures taken to prevent any future occurrence, to the CCDB or its designee within 5 days of receipt of the emergency order. Issuance of an emergency cease and desist order shall not be a bar against, or a prerequisite for, taking any other action against the violator.

ii. Suspension Due to Illicit Discharges in Emergency Situations

The CCDB or its designee may, without prior notice, suspend stormwater drainage system discharge access to a person when such suspension is necessary to stop an actual or threatened discharge which presents or may present imminent and substantial danger to the environment, or to the health or welfare of persons, or to the stormwater drainage system or waters of the state if the violator fails to comply with a suspension order issued in an emergency, the CCDB or its designee may take such steps as deemed necessary to prevent or minimize damage to the stormwater drainage system or waters of the state, or to minimize danger to persons.

iii. Suspension Due to the Detection of Illicit Discharge

Any person discharging to the stormwater drainage system in violation of this ordinance may have their stormwater drainage system access terminated if such termination would abate or reduce an illicit discharge. The CCDB or its designee will notify a violator of the proposed termination of its stormwater drainage system access. The violator may petition the CCDB or its designee for a reconsideration and hearing. A person commits an offense if the person reinstates stormwater drainage system access to premises terminated pursuant to this Section, without the prior approval of the CCDB or its designee.

iv. Criminal Penalties for Violations

For intentional and flagrant violations of this ordinance, the CCDB or its designee may issue a notice to the applicant or other responsible person and the owner of the property, requiring such person to appear in the Circuit or Superior Court of Clark County to answer charges for such violation. Upon conviction, such person shall be punished by a fine as set by the Council of the Clark County, plus costs, damages, and expenses or imprisonment for 60 days or both. Each act of violation and each day upon which any violation shall occur shall constitute a separate offense.

(c) COST OF ABATEMENT OF THE VIOLATION

In addition to any other remedies, should any owner fail to comply with the provisions of this ordinance, the CCDB or its designee may, after giving notice and opportunity for compliance, have the necessary work done, and the owner shall be required to promptly reimburse the CCDB or its designee for all costs of such work.

Nothing herein contained shall prevent the CCDB or its designee from taking such other lawful action as may be necessary to prevent or remedy any violation. All costs connected therewith shall accrue to the person or persons responsible. Costs include, but are not limited to, repairs to the stormwater drainage system made necessary by the violation, as well as those penalties levied by the EPA or IDEM for violation of the Clark County's NPDES permit, administrative costs, attorney fees, court costs, and other costs and expenses associated with the enforcement of this Ordinance, including sampling and monitoring expenses.

If the amount due for abatement of the violation is not paid within a timely manner as determined by the decision of the CCDB or its designee or by the expiration of the time in which to file an appeal, the charges shall become a special assessment against the property and shall constitute a lien on the property for the amount of the assessment.

(d) APPEALS

1. Appeal of Notice of Violation

Any person to whom any provision of this Ordinance has been applied may appeal in writing, not later than 30 days after the action or decision being appealed from, to the Board of Commissioners of the Clark County the action or decision whereby any such provision was so applied. Such appeal shall identify the matter being appealed, and the basis for the appeal. The Board of Commissioners of the CCDB or its designee shall consider the appeal and make a decision whereby it affirms, rejects or modifies the action being appealed. In considering any such appeal, the Board of Commissioners of the Clark County may consider

the recommendations of the Clark County Staff and the comments of other persons having knowledge of the matter. In considering any such appeal, the Board of Commissioners may grant a variance from the terms of this Ordinance to provide relief, in whole or in part, from the action being appealed, but only upon finding that the following requirements are satisfied:

- i. The application of the Ordinance provisions being appealed will present or cause practical difficulties for a development or development site; provided, however, that practical difficulties shall not include the need for the developer to incur additional reasonable expenses in order to comply with the Ordinance; and
- ii. The granting of the relief requested will not substantially prevent the goals and purposes of this Ordinance, nor result in less effective management of stormwater runoff.

2. Enforcement Measures After Appeal

If the violation has not been corrected pursuant to the requirements set forth in the Notice of Violation, or, in the event of an appeal, within 5 days of the decision of the Board of Commissioners upholding the decision of the CCDB or its designee, then representatives of the CCDB or its designee shall enter upon the subject private property and are authorized to take any and all measures necessary to abate the violation and/or restore the property. It shall be unlawful for any person, owner, agent or person in possession of any premises to refuse to allow the CCDB or its designee or its designated contractor to enter upon the premises for the purposes set forth above.



Abbreviations and Definitions

(a) **ABBREVIATIONS**

- BMP** Best Management Practice
- COE** United States Army Corps of Engineers
- CWA** Clean Water Act
- EPA** Environmental Protection Agency
- GIS** Geographical Information System
- IDEM** Indiana Department of Environmental Management
- MS4** Municipal Separate Storm Sewer System
- NRCS** USDA-Natural Resources Conservation Service
- NPDES** National Pollutant Discharge Elimination System
- POTW** Publicly Owned Treatment Works
- SWCD** Soil and Water Conservation District
- SWPPP** Stormwater Pollution Prevention Plan
- USDA** United States Department of Agriculture
- USFWS** United States Fish and Wildlife Service

(b) **DEFINITIONS**

Agricultural land disturbing activity. Tillage, planting, cultivation, or harvesting operations for the production of agricultural or nursery vegetative crops. The term also includes pasture renovation and establishment, the construction of agricultural conservation practices, and the installation and maintenance of agricultural drainage tile.

Base Flow. Stream discharge derived from groundwater sources as differentiated from surface runoff. Sometimes considered to include flows from regulated lakes or reservoirs.

Best Management Practices. Design, construction, and maintenance practices and criteria for stormwater facilities that minimize the impact of stormwater runoff rates and volumes, prevent erosion, and capture pollutants.

Buffer Strip. An existing, variable width strip of vegetated land intended to protect water quality and habitat.

Capacity (of a Storm Drainage Facility). The maximum flow that can be conveyed or stored by a storm drainage facility without causing damage to public or private property.

Catch Basin. A chamber usually built at the curb line of a street for the admission of surface water to a storm drain or subdrain, having at its base a sediment sump designed to retain grit and detritus below the point of overflow.

Certified Professionals. Individuals who are trained and experienced in the principles of stormwater management, including erosion and sediment control as is demonstrated by completion of state registration, or professional certification that enable the individual to make judgments regarding stormwater management, treatment, and design.

Channel. A portion of a natural or artificial watercourse which periodically or continuously contains moving water, or which forms a connecting link between two bodies of water. It has a defined bed and banks which serve to confine the water.

Comprehensive Stormwater Management. A comprehensive stormwater program for effective management of stormwater quantity and quality throughout the community.

Constructed Wetland. A manmade shallow pool that creates growing conditions suitable for wetland vegetation and is designed to maximize pollutant removal.

Construction activity. Land disturbing activities, and land disturbing activities associated with the construction of infrastructure and structures. This term does not include routine ditch or road maintenance or minor landscaping projects.

Construction site access. A stabilized stone surface at all points of ingress or egress to a project site, for the purpose of capturing and detaining sediment carried by tires of vehicles or other equipment entering or exiting the project site.

Construction Support Activities. Include but are not limited to the following: concrete or asphalt batch plants, equipment staging yards, material storage areas, excavated material disposal areas, borrow areas. Such activities must not support multiple, unrelated projects, be a commercial/industrial operation, or continue to operate beyond the completion of the construction activity for the project it supports.

Contiguous. Adjoining or in actual contact with.

Contour. An imaginary line on the surface of the earth connecting points of the same elevation.

Contour Line. Line on a map which represents a contour or points of equal elevation.

Contractor or subcontractor. An individual or company hired by the project site or individual lot owner, their agent, or the individual lot operator to perform services on the project site.

Conveyance. Any structural method for transferring stormwater between at least two points. The term includes piping, ditches, swales, curbs, gutters, catch basins, channels, storm drains, and roadways.

Cross Section. A graph or plot of ground elevation across a stream valley or a portion of it, usually along a line perpendicular to the stream or direction of flow.

Culvert. A closed conduit used for the conveyance of surface drainage water under a roadway, railroad, canal or other impediment.

Dechlorinated swimming pool discharge. Chlorinated water that has either sat idle for seven (7) days following chlorination prior to discharge to the MS4 conveyance, or, by analysis, does not contain detectable concentrations (less than five-hundredths (0.05) milligram per liter) of chlorinated residual.

Design Storm. A selected storm event, described in terms of the probability of occurring once within a given number of years, for which drainage or flood control improvements are designed and built.

Detention. Managing stormwater runoff by temporary holding and controlled release.

Detention Basin. A facility constructed or modified to restrict the flow of stormwater to a prescribed maximum rate, and to detain concurrently the excess waters that accumulate behind the outlet.

Detention Storage. The temporary detaining of storage of stormwater in storage facilities, on rooftops, in streets, parking lots, school yards, parks, open spaces or other areas under predetermined and controlled conditions, with the rate of release regulated by appropriately installed devices.

Detention Time. The theoretical time required to displace the contents of a tank or unit at a given rate of discharge (volume divided by rate of discharge).

Detritus. Dead or decaying organic matter; generally contributed to stormwater as fallen leaves and sticks or as dead aquatic organisms.

Developer. Any person financially responsible for construction activity, or an owner of property who sells or leases, or offers for sale or lease, any lots in a subdivision.

Development. Any man-made change to improved or unimproved real estate including but not limited to:

- i. Construction, reconstruction, or placement of a building or any addition to a building;
- ii. Construction of flood control structures such as levees, dikes, dams or channel improvements;
- iii. Construction or reconstruction of bridges or culverts;
- iv. Installing a manufactured home on a site, preparing a site for a manufactured home, or installing a recreational vehicle on a site for more than hundred eight (180) days;
- v. Installing utilities, erection of walls, construction of roads, or similar projects;
- vi. Mining, dredging, filling, grading, excavation, or drilling operations;
- vii. Storage of materials; or
- viii. Any other activity that might change the direction, height, or velocity of flood or surface waters.

“Development” does not include activities such as the maintenance of existing buildings and facilities such as painting, re-roofing, resurfacing roads, or gardening, plowing and similar agricultural practices that do not involve filling, grading, excavation, or the construction of permanent buildings.

Discharge. Usually the rate of water flow. A volume of fluid passing a point per unit time commonly expressed as cubic feet per second, cubic meters per second, gallons per minute, or millions of gallons per day.

Disposal. The discharge, deposit, injection, spilling, leaking, or placing of any solid waste or hazardous waste into or on any land or water so that the solid waste or hazardous waste, or any constituent of the waste, may enter the environment, be emitted into the air, or be discharged into any waters, including ground waters.

Ditch. A man-made, open watercourse in or into which excess surface water or groundwater drained from land, stormwater runoff, or floodwaters flow either continuously or intermittently.

Drain. A buried slotted or perforated pipe or other conduit (subsurface drain) or a ditch (open drain) for carrying off surplus groundwater or surface water.

Drainage. The removal of excess surface water or groundwater from land by means of ditches or subsurface drains. Also see Natural drainage.

Drainage Area. The area draining into a stream at a given point. It may be of different sizes for surface runoff, subsurface flow and base flow, but generally the surface runoff area is considered as the drainage area.

Dry Well. A type of infiltration practice that allows stormwater runoff to flow directly into the ground via a bored or otherwise excavated opening in the ground surface.

Duration. The time period of a rainfall event.

Environment. The sum total of all the external conditions that may act upon a living organism or community to influence its development or existence.

Erodibility Index (EI). The soil erodibility index (EI) provides a numerical expression of the potential for a soil to erode considering the physical and chemical properties of the soil and the climatic conditions where it is located. The higher the index, the greater the investment needed to maintain the sustainability of the soil resource base if intensively cropped. It is defined to be the maximum of $(R \times K \times LS)/T$ (from the Universal Soil Loss Equation) and $(C \times I)/T$ (from the Wind Erosion Equation), where R is a measure of rainfall and runoff, K is a factor of the susceptibility of the soil to water erosion, LS is a measure of the combined effects of slope length and steepness, C is a climatic characterization of windspeed and surface soil moisture and I is a measure of the susceptibility of the soil to wind erosion. Erodibility Index scores equal to or greater than 8 are considered highly erodible land.

Erosion. The wearing away of the land surface by water, wind, ice, gravity, or other geological agents. The following terms are used to describe different types of water erosion:

- *Accelerated erosion*--Erosion much more rapid than normal or geologic erosion, primarily as a result of the activities of man.
- *Channel erosion* --An erosion process whereby the volume and velocity of flow wears away the bed and/or banks of a well-defined channel.
- *Gully erosion* --An erosion process whereby runoff water accumulates in narrow channels and, over relatively short periods, removes the soil to considerable depths, ranging from 1-2 ft. to as much as 75-100 ft.
- *Rill erosion*--An erosion process in which numerous small channels only several inches deep are formed; occurs mainly on recently disturbed and exposed soils (see Rill).
- *Splash erosion*--The spattering of small soil particles caused by the impact of raindrops on wet soils; the loosened and spattered particles may or may not be subsequently removed by surface runoff.
- *Sheet erosion*--The gradual removal of a fairly uniform layer of soil from the land surface by runoff water.

Erosion and sediment control. A practice, or a combination of practices, to minimize sedimentation by first reducing or eliminating erosion at the source and then as necessary, trapping sediment to prevent it from being discharged from or within a project site.

Filter Strip. Usually a long, relatively narrow area (usually, 20-75 feet wide) of undisturbed or planted vegetation used near disturbed or impervious surfaces to filter stormwater pollutants for the protection of watercourses, reservoirs, or adjacent properties.

Floatable. Any solid waste that will float on the surface of the water.

Flood (or Flood Waters). A general and temporary condition of partial or complete inundation of normally dry land areas from the overflow, the unusual and rapid accumulation, or the runoff of surface waters from any source.

Floodplain. The channel proper and the areas adjoining the channel which have been or hereafter may be covered by the regulatory or 100-year flood. Any normally dry land area that is susceptible to being inundated by water from any natural source. The floodplain includes both the floodway and the floodway fringe districts.

Floodway. The channel of a river or stream and those portions of the floodplains adjoining the channel which are reasonably required to efficiently carry and discharge the peak flow of the regulatory flood of any river or stream.

Floodway Fringe. That portion of the flood plain lying outside the floodway, which is inundated by the regulatory flood.

Fluvial Erosion Hazard (FEH) Corridor. Fluvial Erosion Hazard corridors represent the areas along the streams (including the channel and immediate overbanks areas) that are believed to be subject to stream movement or streambank erosion. These corridors have been delineated for most actively migrating and relatively stationary streams in Indiana through an Indiana Silver Jackets initiative.

Footing Drain. A drain pipe installed around the exterior of a basement wall foundation to relieve water pressure caused by high groundwater elevation.

Garbage. All putrescible animal solid, vegetable solid, and semisolid wastes resulting from the processing, handling, preparation, cooking, serving, or consumption of food or food materials.

Gasoline outlet. An operating gasoline or diesel fueling facility whose primary function is the resale of fuels. The term applies to facilities that create five thousand (5,000) or more square feet of impervious surface, or generate an average daily traffic count of one hundred (100) vehicles per one thousand (1,000) square feet of land area.

Geographical Information System. A computer system capable of assembling, storing, manipulation, and displaying geographically referenced information. This technology can be used for resource management and development planning.

Grade. (1) The inclination or slope of a channel, canal, conduit, etc., or natural ground surface usually expressed in terms of the percentage the vertical rise (or fall) bears to the corresponding horizontal distance. (2) The finished surface of a canal bed, roadbed, top of embankment, or bottom of excavation; any surface prepared to a design elevation for the support of construction, such as paving or the laying of a conduit. (3) To finish the surface of a canal bed, roadbed, top of embankment, or bottom of excavation, or other land area to a smooth, even condition.

Grading. The cutting and filling of the land surface to a desired slope or elevation.

Grass. A member of the botanical family Graminae, characterized by blade-like leaves that originate as a sheath wrapped around the stem.

Groundwater. Accumulation of underground water, natural or artificial. The term does not include manmade underground storage or conveyance structures.

Habitat. The environment in which the life needs of a plant or animal are supplied.

Highly Erodible Land (HEL). Land that has an erodibility index of eight or more.

Hot Spot Development. Projects involving land uses considered to be high pollutant producers such as vehicle service and maintenance facilities, vehicle salvage yards and recycling facilities, vehicle and equipment cleaning facilities, fleet storage areas for buses, trucks, etc., industrial/commercial or any hazardous waste storage areas or areas that generate such wastes, industrial sites, restaurants and convenience stores, any activity involving chemical mixing or loading/unloading, outdoor liquid container

storage, public works storage areas, commercial container nurseries, and some high traffic retail uses characterized by frequent vehicle turnover.

Hydrologic Unit Code. A numeric United States Geologic Survey code that corresponds to a watershed area. Each area also has a text description associated with the numeric code.

Hydrology. The science of the behavior of water in the atmosphere, on the surface of the earth, and underground. A typical hydrologic study is undertaken to compute flow rates associated with specified flood events.

Illicit Discharge. Any discharge to a conveyance that is not composed entirely of stormwater except naturally occurring floatables, such as leaves or tree limbs.

Impaired Waters. Waters that do not or are not expected to meet applicable water quality standards, as included on IDEM's CWA Section 303(d) List of Impaired Waters.

Impervious surface. Surfaces, such as pavement and rooftops, which prevent the infiltration of stormwater into the soil.

Individual building lot. A single parcel of land within a multi-parcel development.

Individual lot operator. A contractor or subcontractor working on an individual lot.

Individual lot owner. A person who has financial control of construction activities for an individual lot.

Infiltration. Passage or movement of water into the soil. Infiltration practices include any structural BMP designed to facilitate the percolation of runoff through the soil to groundwater. Examples include infiltration basins or trenches, dry wells, and porous pavement.

Inlet. An opening into a storm drain system for the entrance of surface stormwater runoff, more completely described as a storm drain inlet.

Land-disturbing Activity. Any man-made change of the land surface, including removing vegetative cover that exposes the underlying soil, excavating, filling, transporting and grading.

Land Surveyor. A person licensed under the laws of the State of Indiana to practice land surveying.

Larger common plan of development or sale. A plan, undertaken by a single project site owner or a group of project site owners acting in concert, to offer lots for sale or lease; where such land is contiguous, or is known, designated, purchased or advertised as a common unit or by a common name, such land shall be presumed as being offered for sale or lease as part of a larger common plan. The term also includes phased or other construction activity by a single entity for its own use.

Lowest Adjacent Grade. The elevation of the lowest grade adjacent to a structure, where the soil meets the foundation around the outside of the structure (including structural members such as basement walkout, patios, decks, porches, support posts or piers, and rim of the window well).

Lowest Floor. Refers to the lowest of the following:

- i. The top of the basement floor;
- ii. The top of the garage floor, if the garage is the lowest level of the building;
- iii. The top of the first floor of buildings constructed on a slab or of buildings elevated on pilings or constructed on a crawl space with permanent openings; or
- iv. The top of the floor level of any enclosure below an elevated building where the walls of the enclosure provide any resistance to the flow of flood waters unless:
 1. The walls are designed to automatically equalize the hydrostatic flood forces on the walls by allowing for the entry and exit of flood waters, by providing a minimum of two

- opening (in addition to doorways and windows) having a total area of one (1) square foot for every two (2) square feet of enclosed area subject to flooding. The bottom of all such openings shall be no higher than one (1) foot above grade.
2. Such enclosed space shall be usable only for the parking of vehicles or building access.

Manhole. Storm drain structure through which a person may enter to gain access to an underground storm drain or enclosed structure.

Measurable storm event. A precipitation event that results in a total measured precipitation accumulation equal to, or greater than, one-half (0.5) inch of rainfall.

Mulch. A natural or artificial layer of plant residue or other materials covering the land surface which conserves moisture, holds soil in place, aids in establishing plant cover, and minimizes temperature fluctuations.

Municipal Separate Storm Sewers. An MS4 meets all the following criteria: (1) is a conveyance or system of conveyances owned by the state, county, city, town, or other public entity; (2) discharges to waters of the U.S.; (3) is designed or used for collecting or conveying stormwater; (4) is not a combined sewer; and, (5) is not part of a Publicly Owned Treatment Works (POTW).

National Pollutant Discharge Elimination System. A permit developed by the U.S. EPA through the Clean Water Act. In Indiana, the permitting process has been delegated to IDEM. This permit covers aspects of municipal stormwater quality.

Natural Drainage. The flow patterns of stormwater runoff over the land in its pre-development state.

Nutrient(s). (1) A substance necessary for the growth and reproduction of organisms. (2) In water, those substances (chiefly nitrates and phosphates) that promote growth of algae and bacteria.

Open Drain. A natural watercourse or constructed open channel that conveys drainage water.

Open Space. Any land area devoid of any disturbed or impervious surfaces created by industrial, commercial, residential, agricultural, or other manmade activities.

Outfall. The point, location, or structure where a pipe or open drain discharges to a receiving body of water.

Outlet. The point of water disposal from a stream, river, lake, tidewater, or artificial drain.

Peak Discharge (or Peak Flow). The maximum instantaneous flow from a given storm condition at a specific location.

Percolation. The movement of water through soil.

Permanent stabilization. The establishment, at a uniform density of seventy percent (70%) across the disturbed area, of vegetative cover or permanent non-erosive material that will ensure the resistance of the soil to erosion, sliding, or other movement.

Pervious. Allowing movement of water.

Point Source. Any discernible, confined, and discrete conveyance including but not limited to any pipe, ditch, channel, tunnel, conduit, well, discrete fissure, or container from which pollutants are or maybe discharged (P.L. 92-500, Section 502[14]).

Porous pavement. A type of infiltration practice to improve the quality and reduce the quantity of stormwater runoff via the use of manmade, pervious pavement which allows runoff to percolate through the pavement and into underlying soils

Professional Engineer. A person licensed under the laws of the State of Indiana to practice professional engineering.

Project site. The entire area on which construction activity is to be performed.

Project site owner. The person required to submit a stormwater permit application and required to comply with the terms of this ordinance, including a developer or a person who has financial and operational control of construction activities, and project plans and specifications, including the ability to make modifications to those plans and specifications.

Rain garden. A vegetative practice used to alter impervious surfaces, such as roofs, into pervious surfaces for absorption and treatment of rainfall.

Receiving Stream, Receiving Channel, or Receiving Water. The body of water into which runoff or effluent is discharged. The term does not include private drains, unnamed conveyances, retention and detention basins, or constructed wetlands used as treatment.

Recharge. Replenishment of groundwater reservoirs by infiltration and transmission from the outcrop of an aquifer or from permeable soils.

Redevelopment. Development occurring on a previously developed site.

Refueling area. An operating gasoline or diesel fueling area whose primary function is to provide fuel to equipment or vehicles.

Regional Pond. A detention/retention basin sized to detain/retain the runoff from the entire watershed, on-site and off-site, tributary to the pond's outlet.

Regulatory Flood. The discharge or elevation associated with the 100-year flood as calculated by a method and procedure which is acceptable to and approved by the Indiana Department of Natural Resources and the Federal Emergency Management Agency. The "regulatory flood" is also known as the "base flood".

Regulatory Floodway. See Floodway.

Release Rate. The amount of stormwater release from a stormwater control facility per unit of time.

Reservoir. A natural or artificially created pond, lake or other space used for storage, regulation or control of water. May be either permanent or temporary. The term is also used in the hydrologic modeling of storage facilities.

Retention. The storage of stormwater to prevent it from leaving the development site. May be temporary or permanent.

Retention basin. A type of storage practice, that has no positive outlet, used to retain stormwater runoff for an indefinite amount of time. Runoff from this type of basin is removed only by infiltration through a porous bottom or by evaporation.

Return Period. The average interval of time within which a given rainfall event will be equaled or exceeded once. A flood having a return period of 100 years has a one percent probability of being equaled or exceeded in any one year.

Riparian zone. Of, on, or pertaining to the banks of a stream, river, or pond.

Riparian habitat. A land area adjacent to a waterbody that supports animal and plant life associated with that waterbody.

Runoff. That portion of precipitation that flows from a drainage area on the land surface, in open channels, or in stormwater conveyance systems.

Runoff Coefficient. A decimal fraction relating the amount of rain which appears as runoff and reaches the storm drain system to the total amount of rain falling. A coefficient of 0.5 implies that 50 percent of the rain falling on a given surface appears as stormwater runoff.

Sediment. Solid material (both mineral and organic) that is in suspension, is being transported, or has been moved from its site of origin by air, water, gravity, or ice and has come to rest on the earth's surface.

Sedimentation. The process that deposits soils, debris and other unconsolidated materials either on the ground surfaces or in bodies of water or watercourses.

Sensitive Water. A waterbody is in need of priority protection or remediation based on its:

- i. Providing habitat for threatened or endangered species,
- ii. Usage as a public water supply intake,
- iii. Relevant community value,
- iv. Usage for full body contact recreation,
- v. exceptional use classification as found in 327 IAC 2-1-11(b),
- vi. Outstanding state resource water classification as found in 327 IAC 2-1-2(3) and 327 IAC 2-1.5-19(b).

Silvicultural. the practice of controlling the establishment, growth, composition, health, and quality of forests to meet diverse needs and values.

- i. Nonpoint activities include source silvicultural activities such as nursery operations, site preparation, reforestation and subsequent cultural treatment, thinning, prescribed burning, pest and fire control, harvesting operations, surface drainage, or road construction and maintenance from which there is natural runoff. Some of these activities (such as stream crossing for roads) may involve the placement of dredged or fill material which may require a CWA section 404 permit and a 401 Water Quality Certification.
- ii. Point source activities include any discernible, confined and discrete conveyance related to rock crushing, gravel washing, log sorting, or log storage facilities which are operated in connection with silvicultural activities and from which pollutants are discharged into waters of the United States or the State.

Site. The entire area included in the legal description of the land on which land disturbing activity is to be performed.

Slope. Degree of deviation of a surface from the horizontal, measured as a numerical ratio or percent. Expressed as a ratio, the first number is commonly the horizontal distance (run) and the second is the vertical distance (rise)--e.g., 2:1. However, the preferred method for designation of slopes is to clearly identify the horizontal (H) and vertical (V) components (length (L) and Width (W) components for horizontal angles). Also note that according to international standards (Metric), the slopes are presented as the vertical or width component shown on the numerator--e.g., 1V:2H. Slope expressions in this Ordinance follow the common presentation of slopes--e.g., 2:1 with the metric presentation shown in parentheses--e.g., (1V:2H). Slopes can also be expressed in "percent". Slopes given in percent are always expressed as $(100 \cdot V/H)$ --e.g., a 2:1 (1V:2H) slope is a 50% slope.

Soil. The unconsolidated mineral and organic material on the immediate surface of the earth that serves as a natural medium for the growth of land plants.

Soil and Water Conservation District. A public organization created under state law as a special-purpose district to develop and carry out a program of soil, water, and related resource conservation, use, and development within its boundaries. A subdivision of state government with a local governing body, established under IC 14-32.

Solid Waste. Any garbage, refuse, debris, or other discarded material.

Spill. The unexpected, unintended, abnormal, or unapproved dumping, leakage, drainage, seepage, discharge, or other loss of petroleum, hazardous substances, extremely hazardous substances, or objectionable substances. The term does not include releases to impervious surfaces when the substance does not migrate off the surface or penetrate the surface and enter the soil.

Storm Duration. The length of time that water may be stored in any stormwater control facility, computed from the time water first begins to be stored.

Storm Event. An estimate of the expected amount of precipitation within a given period of time. For example, a 10-yr. frequency, 24-hr. duration storm event is a storm that has a 10% probability of occurring in any one year. Precipitation is measured over a 24-hr. period.

Storm Sewer. A closed conduit for conveying collected stormwater, while excluding sewage and industrial wastes. Also called a storm drain.

Stormwater. Water resulting from rain, melting or melted snow, hail, or sleet.

Stormwater Management System. A collection of structural and non-structural practices and infrastructure designed to manage stormwater on a site. This system may include but is not limited to erosion control measures, storm drainage infrastructure, detention/retention facilities, and stormwater quality BMP's.

Stormwater Pollution Prevention Plan. A plan developed to minimize the impact of stormwater pollutants resulting from construction activities.

Stormwater Runoff. The water derived from rains falling within a tributary basin, flowing over the surface of the ground or collected in channels or conduits.

Stormwater Quality Management Plan. A comprehensive written document that addresses stormwater runoff quality.

Stormwater Quality Measure. A practice, or a combination of practices, to control or minimize pollutants associated with stormwater runoff.

Stormwater Drainage System. All means, natural or man-made, used for conducting stormwater to, through or from a drainage area to any of the following: conduits and appurtenant features, canals, channels, ditches, storage facilities, swales, streams, culverts, streets and pumping stations.

Strip Development. A multi-lot project where building lots front on an existing road.

Subdivision, Major. Any land that is divided or proposed to be divided into four (4) or more lots, whether contiguous or subject to zoning requirements, for the purpose of sale or lease as part of a larger common plan of development or sale.

Subdivision, Minor. Any land that is divided or proposed to be divided into less than four (4) lots, whether contiguous or subject to zoning requirements, for the purpose of sale or lease as part of a larger common plan of development or sale.

Subsurface Drain. A pervious backfield trench, usually containing stone and perforated pipe, for intercepting groundwater or seepage.

Surface Runoff. Precipitation that flows onto the surfaces of roofs, streets, the ground, etc., and is not absorbed or retained by that surface but collects and runs off.

Swale. An elongated depression in the land surface that is at least seasonally wet, is usually heavily vegetated, and is normally without flowing water. Swales conduct stormwater into primary drainage channels and may provide some groundwater recharge.

Temporary Stabilization. The covering of soil to ensure its resistance to erosion, sliding, or other movement. The term includes vegetative cover, anchored mulch, or other non-erosive material applied at a uniform density of seventy percent (70%) across the disturbed area.

Tile Drain. Pipe made of perforated plastic, burned clay, concrete, or similar material, laid to a designed grade and depth, to collect and carry excess water from the soil.

Topographic Map. Graphical portrayal of the topographic features of a land area, showing both the horizontal distances between the features and their elevations above a given datum.

Topography. The representation of a portion of the earth's surface showing natural and man-made features of a give locality such as rivers, streams, ditches, lakes, roads, buildings and most importantly, variations in ground elevations for the terrain of the area.

Trained individual. An individual who is trained and experienced in the principles of stormwater quality, including erosion and sediment control as may be demonstrated by state registration, professional certification (such as CESSWI and/or CPESC certification), or other documented and applicable experience or coursework as deemed sufficient by the CCDB or its designee that enable the individual to make judgments regarding stormwater control or treatment and monitoring.

Urban Drain. A drain defined as "Urban Drain" in Indiana Drainage Code.

Urbanization. The development, change or improvement of any parcel of land consisting of one or more lots for residential, commercial, industrial, institutional, recreational or public utility purposes.

Vegetated swale. A type of vegetative practice used to filter stormwater runoff via a vegetated, shallow-channel conveyance.

Water Quality. A term used to describe the chemical, physical, and biological characteristics of water, usually in respect to its suitability for a particular purpose.

Water Resources. The supply of groundwater and surface water in a given area.

Waterbody. Any accumulation of water, surface, or underground, natural or artificial, excluding water features designed and designated as water pollution control facilities.

Watercourse. Any river, stream, creek, brook, branch, natural or man-made drainageway in or into which stormwater runoff or floodwaters flow either continuously or intermittently.

Watershed. The region drained by or contributing water to a specific point that could be along a stream, lake or other stormwater facility. Watersheds are often broken down into subareas for the purpose of hydrologic modeling.

Watershed Area. All land and water within the confines of a drainage divide. See also Watershed.

Wetlands. Areas that are inundated or saturated by surface water or groundwater at a frequency and duration sufficient to support, and that under normal circumstances do support, a prevalence of vegetation typically adapted for life in saturated soil conditions.

**STORMWATER TECHNICAL
STANDARDS MANUAL
CLARK COUNTY, INDIANA**

EXHIBIT “B”



Chapter Two

METHODOLOGY FOR DETERMINATION OF RUNOFF RATES

Runoff rates shall be computed for the area of the parcel under development plus the area of the watershed flowing into the parcel under development. The rate of runoff which is generated as the result of a given rainfall intensity may be calculated as follows:

A. DEVELOPMENT SITES LESS THAN OR EQUAL TO 5 ACRES IN SIZE, WITH A CONTRIBUTING DRAINAGE AREA LESS THAN OR EQUAL TO 25 ACRES AND NO DEPRESSIONAL STORAGE

The Rational Method may be used. A computer model, such as TR-55 (NRCS), TR-20 (NRCS), HEC-HMS (COE), and HEC-1 (COE), that can generate hydrographs based on the NRCS TR-55 time of concentration and curve number calculation methodologies may also be used along with a 24-hour duration NRCS Type 2 storm. Note that for the purpose of determining the post-developed conditions curve numbers, due to significant disturbance to the upper soil layers during the construction activities, the initially determined hydrologic soil group for disturbed areas should be changed to the next less infiltrating capacity category (i.e., A to B, B to C, and C to D).

LID Exception: If Low Impact Development (LID) approach is pursued in satisfying the requirements noted in Chapter 8 (Post-Construction Stormwater Quality Management Standards), the post-developed CN for the protected undisturbed or restored disturbed areas meeting the requirements described in Chapter 8 and BMP fact sheets may be determined based on pre-development underlying soil layer.

In the Rational Method, the peak rate of runoff, Q , in cubic feet per second (cfs) is computed as:

$$Q = CIA$$

Where: C = Runoff coefficient, representing the characteristics of the drainage area and defined as the ratio of runoff to rainfall.

I = Average intensity of rainfall in inches per hour for a duration equal to the time of concentration (t_c) for a selected rainfall frequency.

A = Tributary drainage area in acres.

Values for the runoff coefficient "C" are provided in Tables 2-1 and 2-2, which show values for different types of surfaces and local soil characteristics. The composite "C" value used for a given drainage area with various surface types shall be the weighted average value for the total area calculated from a breakdown of individual areas having different surface types. Table 2-3 provides runoff coefficients and inlet times for different land use classifications.

Rainfall intensity shall be determined from the rainfall frequency data shown in **Table 2-4**.

In general, the time of concentration (t_c) methodology to be used for all stormwater management projects within Clark County shall be as outlined in the U.S. Department of Agriculture (USDA) - NRCS TR-55 Manual. In urban or developed areas, the methodology to be used shall be the sum of the inlet time and flow time in the stormwater facility from the most remote part of the drainage area to the point under consideration. The flow time in the storm sewers may be estimated by the distance in feet divided by velocity of flow in feet per second. The velocity shall be determined by the Manning's Equation (see Chapter 4). Inlet time is the combined time required for the runoff to reach the inlet of the storm sewer. It includes overland flow time and flow time through established surface drainage channels such as swales, ditches, and sheet flow across such areas as lawns, fields, and other graded surfaces.

TABLE 2-1

Urban Runoff Coefficients				
<i>Type of Surface</i>	<i>Runoff Coefficient "C"</i> <i>(by Storm Recurrence Interval)</i>			
	<i>< 25 year</i>	<i>25 year</i>	<i>50 year</i>	<i>100 year</i>
□ Hard Surfaces				
Asphalt	0.82	0.90	1.00	1.00
Gravel	0.85	0.94	1.00	1.00
Concrete	0.85	0.94	1.00	1.00
Roof	0.85	0.94	1.00	1.00
□ Lawns (Sandy)				
Flat (0-2% Slope)	0.07	0.08	0.09	0.12
Rolling (2-7% Slope)	0.12	0.13	0.16	0.20
Steep (Greater than 7% Slope)	0.17	0.19	0.22	0.28
□ Lawns (Clay)				
Flat (0-2% Slope)	0.16	0.18	0.21	0.26
Rolling (2-7% Slope)	0.21	0.23	0.28	0.35
Steep (Greater than 7% Slope)	0.30	0.33	0.40	0.50

Source: HERPICC Stormwater Drainage Manual, July 1995, and other sources.

TABLE 2-2

Rural Runoff Coefficients				
<i>Type of Surface</i>	<i>Runoff Coefficient "C"</i> <i>(by Storm Recurrence Interval)</i>			
	<i>< 25 year</i>	<i>25 year</i>	<i>50 year</i>	<i>100 year</i>
□ Woodland (Sandy)				
Flat (0-2% Slope)	0.10	0.11	0.13	0.17
Rolling (2-7% Slope)	0.25	0.28	0.33	0.41
Steep (Greater than 7% Slope)	0.30	0.33	0.40	0.50
□ Woodland (Clay)				
Flat (0-2% Slope)	0.30	0.33	0.40	0.50
Rolling (2-7% Slope)	0.35	0.39	0.46	0.58
Steep (Greater than 7% Slope)	0.50	0.55	0.66	0.83
□ Pasture (Sandy)				
Flat (0-2% Slope)	0.10	0.11	0.13	0.17
Rolling (2-7% Slope)	0.16	0.18	0.21	0.26
Steep (Greater than 7% Slope)	0.22	0.24	0.29	0.36
□ Pasture (Clay)				
Flat (0-2% Slope)	0.30	0.33	0.40	0.50
Rolling (2-7% Slope)	0.36	0.40	0.48	0.59
Steep (Greater than 7% Slope)	0.42	0.46	0.55	0.69
□ Cultivated (Sandy)				
Flat (0-2% Slope)	0.30	0.33	0.40	0.50
Rolling (2-7% Slope)	0.40	0.44	0.53	0.66
Steep (Greater than 7% Slope)	0.52	0.57	0.69	0.86
□ Cultivated (Clay)				
Flat (0-2% Slope)	0.50	0.55	0.66	0.83
Rolling (2-7% Slope)	0.60	0.66	0.79	0.99
Steep (Greater than 7% Slope)	0.72	0.79	0.95	1.00

Source: HERPICC Stormwater Drainage Manual, July 1995, and other sources.

TABLE 2-3

Runoff Coefficients by Land Use, Typical Inlet Times, and Storm Recurrence Interval													
<i>Land Use</i>	<i>Runoff Coefficients "C"</i> <i>(by Storm Recurrence Interval)</i>												<i>Inlet Time (Minutes)</i> <i>(4)</i>
	<i>Flat</i> <i>(1)</i>				<i>Rolling</i> <i>(2)</i>				<i>Steep</i> <i>(3)</i>				
	<i>< 25 year</i>	<i>25 year</i>	<i>50 year</i>	<i>100 year</i>	<i>< 25 year</i>	<i>25 year</i>	<i>50 year</i>	<i>100 year</i>	<i>< 25 year</i>	<i>25 year</i>	<i>50 year</i>	<i>100 year</i>	
Commercial (CBD)	0.75	0.83	0.99	1.00	0.83	0.91	1.00	1.00	0.91	1.00	1.00	1.00	5
Commercial (Neighborhood)	0.54	0.59	0.71	0.89	0.60	0.66	0.79	0.99	0.66	0.73	0.87	1.00	5 - 10
Industrial	0.63	0.69	0.83	1.00	0.70	0.77	0.92	1.00	0.77	0.85	1.00	1.00	
Garden Apartments	0.54	0.59	0.71	0.89	0.60	0.66	0.79	0.99	0.66	0.73	0.87	1.00	
Churches	0.54	0.59	0.71	0.89	0.60	0.66	0.79	0.99	0.66	0.73	0.87	1.00	
Schools	0.31	0.34	0.41	0.51	0.35	0.39	0.46	0.58	0.39	0.43	0.51	0.64	10 - 15
Semi Detached Residential	0.45	0.50	0.59	0.74	0.50	0.55	0.66	0.83	0.55	0.61	0.73	0.91	
Detached Residential	0.40	0.44	0.53	0.66	0.45	0.50	0.59	0.74	0.50	0.55	0.66	0.83	
Quarter Acre Lots	0.36	0.40	0.48	0.59	0.40	0.44	0.53	0.66	0.44	0.48	0.58	0.73	
Half Acre Lots	0.31	0.34	0.41	0.51	0.35	0.39	0.46	0.58	0.39	0.43	0.51	0.64	
Parkland	0.18	0.20	0.24	0.30	0.20	0.22	0.26	0.33	0.22	0.24	0.29	0.36	To be Computed

Source: HERPICC Stormwater Drainage Manual, July 1995, and other sources.

- (1) Flat terrain involves slopes of 0-2%.
- (2) Rolling terrain involves slopes of 2-7%.
- (3) Steep terrain involves slopes greater than 7%.
- (4) Interpolation, extrapolation and adjustment for local conditions shall be based on engineering experience and judgment.

B. DEVELOPMENT SITES GREATER THAN 5 ACRES IN SIZE OR CONTRIBUTING DRAINAGE AREA GREATER THAN 25 ACRES OR WITH SIGNIFICANT DEPRESSIONAL STORAGE

The runoff rate for these development sites and contributing drainage areas shall be determined by a computer model that can generate hydrographs based on the NRCS TR-55 time of concentration and curve number calculation methodologies. Note that for the purpose of determining the post-developed conditions curve numbers, due to significant disturbance to the upper soil layers during the construction activities, the initially determined hydrologic soil group for disturbed areas should be changed to the next less infiltrating capacity category (i.e., A to B, B to C, and C to D).

LID Exception: If Low Impact Development (LID) approach is pursued in satisfying the requirements noted in Chapter 8 (Post-Construction Stormwater Quality Management Standards), the post-developed CN for the protected undisturbed or restored disturbed areas meeting the requirements described in Chapter 8 and BMP fact sheets may be determined based on pre-development underlying soil layer.

The 24-hour NRCS Type 2 Rainfall Distribution shall be utilized for runoff calculations. 24-hour Rainfall depth for various frequencies shall be taken from **Table 2-5**.

The NRCS Type 2 distribution ordinates are found in **Table 2-6**. This table should be used only when the rainfall distribution is not a default option in the computer program. Examples of computer models that can generate such hydrographs include TR-55 (NRCS), TR-20 (NRCS), and HEC-HMS (COE). These programs may be downloaded free of charge from the associated agencies' web sites. Other models may be acceptable on a case by case basis.

TABLE 2-4

Rainfall Intensities for Various Return Periods and Storm Durations						
<i>Duration</i>	<i>Intensity (Inches/Hour)</i>					
	<i>Return Period (Years)</i>					
	2	5	10	25	50	100
5 min	4.92	6.19	7.07	8.11	8.92	9.68
10 min	3.84	4.81	5.45	6.2	6.75	7.29
15 min	3.13	3.94	4.47	5.11	5.57	6.04
30 min	2.1	2.7	3.1	3.61	3.98	4.36
1 hr	1.29	1.69	1.98	2.34	2.62	2.91
2 hr	0.769	1.02	1.19	1.43	1.62	1.82
3 hr	0.55	0.729	0.859	1.03	1.18	1.33
6 hr	0.337	0.445	0.524	0.633	0.721	0.816
12 hr	0.198	0.261	0.306	0.368	0.417	0.47
24 hr	0.119	0.158	0.186	0.225	0.256	0.29

Source: NOAA, National Weather Service, "Precipitation-Frequency Atlas of the United States", NOAA Atlas 14, Volume 2, Version 3, rev 2006, for central Clark County, Indiana. (values for intermediate durations can be logarithmically interpolated.) (All rainfall intensities are based on Annual Maximum series)

TABLE 2-5

Rainfall Depths for Various Return Periods							
<i>Duration</i>	<i>Depth (Inches)</i>						
	<i>Return Period (Years)</i>						
	1	2	5	10	25	50	100
24 Hrs.	2.59	3.11	3.87	4.5	5.41	6.17	6.99

Source: NOAA, National Weather Service, "Precipitation-Frequency Atlas of the United States", NOAA Atlas 14, Volume 2, Version 2, rev 2006, for central Clark County, Indiana. (Rainfall depths for 2- through 100-year storm are based on annual maximum series. 1-year rainfall depth is based on partial duration series)

TABLE 2-6

NRCS Type II Rainfall Distribution Ordinates					
<i>Cumulative Storm Time (hr)</i>	<i>Cumulative Percent of Storm Depth</i>	<i>Cumulative Storm Time (hr)</i>	<i>Cumulative Percent of Storm Depth</i>	<i>Cumulative Storm Time (hr)</i>	<i>Cumulative Percent of Storm Depth</i>
0.00	0	8.25	12.6	16.50	89.3
0.25	0.2	8.50	13.3	16.75	89.8
0.50	0.5	8.75	14	17.00	90.3
0.75	0.8	9.00	14.7	17.25	90.8
1.00	1.1	9.25	15.5	17.50	91.3
1.25	1.4	9.50	16.3	17.75	91.8
1.50	1.7	9.75	17.2	18.00	92.2
1.75	2	10.00	18.1	18.25	92.6
2.00	2.3	10.25	19.1	18.50	93
2.25	2.6	10.50	20.3	18.75	93.4
2.50	2.9	10.75	21.8	19.00	93.8
2.75	3.2	11.00	23.6	19.25	94.2
3.00	3.5	11.25	25.7	19.50	94.6
3.25	3.8	11.50	28.3	19.75	95
3.50	4.1	11.75	38.7	20.00	95.3
3.75	4.4	12.00	66.3	20.25	95.6
4.00	4.8	12.25	70.7	20.50	95.9
4.25	5.2	12.50	73.5	20.75	96.2
4.50	5.6	12.75	75.8	21.00	96.5
4.75	6	13.00	77.6	21.25	96.8
5.00	6.4	13.25	79.1	21.50	97.1
5.25	6.8	13.50	80.4	21.75	97.4
5.50	7.2	13.75	81.5	22.00	97.7
5.75	7.6	14.00	82.5	22.25	98
6.00	8	14.25	83.4	22.50	98.3
6.25	8.5	14.50	84.2	22.75	98.6
6.50	9	14.75	84.9	23.00	98.9
6.75	9.5	15.00	85.6	23.25	99.2
7.00	10	15.25	86.3	23.50	99.5
7.25	10.5	15.50	86.9	23.75	99.8
7.50	11	15.75	87.5	24.00	100
7.75	11.5	16.00	88.1		
8.00	12	16.25	88.7		

Resources Conservation Service (NRCS), "TR-20 Computer Program for Project Formulation Hydrology", page F9, May 1982.

NOTE: For use only when SCS Type II rainfall distribution is not a default option in the computer program.

C. DEVELOPMENT SITES WITH DRAINAGE AREAS GREATER THAN OR EQUAL TO ONE SQUARE MILE

For the design of any major drainage system, as defined in **Appendix A**, the discharge must be obtained from, or be accepted by, the IDNR. Other portions of the site must use the discharge methodology in the applicable section of this Chapter.



Chapter Three

METHODOLOGY FOR DETERMINATION OF RETENTION/DETENTION STORAGE VOLUMES

The required volume of stormwater storage for all development sites shall be computed using a computer model that can generate hydrographs based on the NRCS TR-55 time of concentration and curve number calculation methodologies. Examples of computer models that can generate such hydrographs include TR-55 (NRCS), TR-20 (NRCS), and HEC-HMS (COE). Other models may be acceptable on a case by case basis.

A. POST-DEVELOPMENT HYDROLOGIC PARAMETERS

Note that for the purpose of determining the post-developed conditions curve numbers, due to significant disturbance to the upper soil layers during the construction activities, the initially determined hydrologic soil group for disturbed areas should be changed to the next less infiltrating capacity category (i.e., A to B, B to C, and C to D).

LID Exception: If Low Impact Development (LID) approach is pursued in satisfying the requirements noted in Chapter 8 (Post-Construction Stormwater Quality Management Standards), the post-developed CN for the protected undisturbed or restored disturbed areas meeting the requirements described in Chapter 8 and BMP fact sheets may be determined based on pre-development underlying soil layer.

B. DESIGN STORM & ALLOWABLE RELEASE RATES FOR DEVELOPMENT SITES WITH ON-SITE DETENTION FACILITIES

The 24-hour NRCS Type 2 Rainfall Distribution shall be utilized to determine the required storage volume. The allowable release rates shall be determined based on methodologies provided in Chapter 6 of these Technical Standards document.

C. DESIGN STORM & ALLOWABLE RELEASE RATES FOR DEVELOPMENT SITES WITHIN A DESIGNATED DRAINAGE AREA SERVICED BY A REGIONAL DETENTION FACILITY

Development sites within Designated Drainage Areas making use of regional detention ponds are typically not required to provide on-site detention.

Where a regional detention facility is servicing or is planned to service a sub-watershed area, and that sub-watershed has been declared a Designated Drainage Area to raise the necessary Infrastructure Development Fees in lieu of providing on-site detention, the following method shall be used to determine the size of storage space that would have been required on-site. This estimated storage volume will be used to determine the fee based on the development site's proportionate share of regional detention storage.

The 24-hour NRCS Type 2 Rainfall Distribution shall be utilized to determine the required storage volume. The stormwater model should not include an on-site detention facility. The outflow hydrograph at the downstream-most point in the site's stormwater system shall be compared to the allowable release rate for the Designated Drainage Area to determine the required storage volume. The allowable release rate for a Designated Drainage Area shall be as defined by the resolution forming the Designated Drainage Area.

The storage volume shall be determined by calculating the volume of outflow from the site that exceeds the given allowable release rate. For example, if a 50-acre site is located in a Designated Drainage Area that has an allowable post-development 100-year release rate of 0.2 cfs/acre, the required storage volume for the site would be equal to the volume of water represented by the cross-hatched area in Figure 3-1.

FIGURE 3-1
Required Storage Volume Determination Example

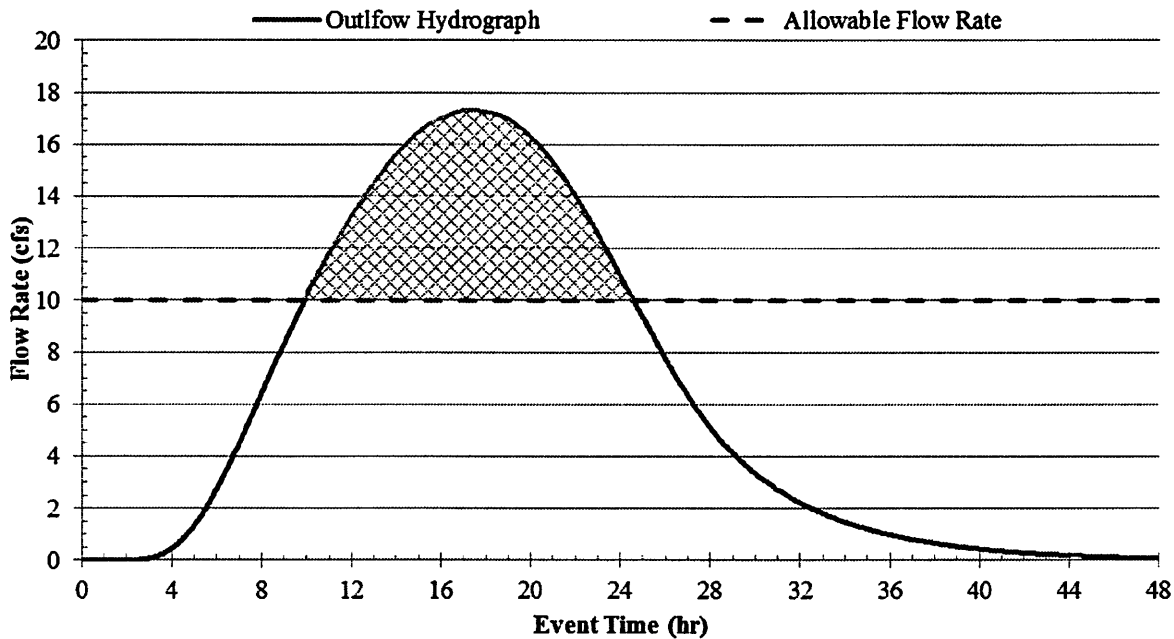



Chapter Four

STORM SEWER DESIGN STANDARDS AND SPECIFICATIONS

All storm sewers, whether private or public, and whether constructed on private or public property shall conform to the design standards and other requirements contained herein. Proposed storm sewer systems must be sized and designed to convey at least the 10-year frequency on-site stormwater runoff, as well as the anticipated 10-year frequency tributary off-site stormwater runoff based on the future developed condition (using Table 6-1 of the Technical Standards). An analysis of the emergency routing of stormwater runoff through the subject development must be provided to confirm that the development will not obstruct the free flow of floodwaters from the tributary off-site property in its current condition and after development. In addition, the Drainage System Overflow Design must be completed in accordance with Section M of this chapter to ensure the safe routing of flood waters through the subject development with the tributary off-site property in its current condition and after development.

A. DESIGN STORM FREQUENCIES

1. All storm sewers, inlets, catch basins, and street gutters shall accommodate (subject to the "allowable spread" provisions discussed later in this Section), as a minimum, peak runoff from a 10-year return frequency storm calculated based on methodology described in Chapter 2. Additional discharges to storm sewer systems allowed in Section L below of this Section must be considered in all design calculations.
2. Culvert capacities for conveyance under interior local, collector, or arterial streets without roadway overtopping shall be the runoff resulting from the 25-year, 50-year, and 100-year frequency storms, respectively, for off-site areas under existing condition and on-site areas under post-developed conditions. Driveway culvert capacities shall be capacities required for the street classification to which the driveway connects. Greater culvert capacity shall be required to protect the finished floor elevation of buildings from the post-developed 100-year frequency storm when, in the opinion of the design engineer or the CCDB or designee, the finished floor elevation is threatened. If the street or road provides the only access to or from any portion of any commercial or residential development, the crossing shall be designed for a minimum of 100-year frequency storm.
3. For portions of the system considered minor drainage systems, the allowable spread of water on Collector Streets for the design storm is limited to maintaining two clear 10-foot moving lanes of traffic. One lane is to be maintained on Local Roads, while other access lanes (such as a subdivision cul-de-sac) can have a water spread equal to one-half of their total width.
4. To ensure access to buildings and allow the use of the roadway by emergency vehicles during storms larger than the design storm, an overflow channel/swale between sag inlets and overflow paths or basin shall be provided at sag inlets so that the maximum depth of water that might be ponded in the street sag shall not exceed 7 inches measured from elevation of gutter. All water shall be contained in the right-of-way for a 100-year storm.
5. Facilities functioning as a major drainage system as defined in **Appendix A** must also meet IDNR design standards in addition to the Clark County standards. In case of discrepancy, the most restrictive requirements shall apply.

6. New drain tiles and pipes, smaller than 24 inches in diameter, shall be placed in a 20-foot easement (10 feet from centerline on each side) and shall be designated on the record plat as 20-foot Drain Easement. Pipes that are 24 inches or larger in diameter, shall be placed in a 30-foot easement (15 feet from centerline on each side) and shall be designated on the record plat as 30-foot Drain Easement. Wider easements may be required by the CCDB or designee when the depth of pipe is greater than 6 to 10 feet, depending on the pipe size.

B. DETERMINATION OF HYDRAULIC CAPACITY FOR STORM SEWERS USING MANNING'S EQUATION

Determination of hydraulic capacity for storm sewers sized by the Rational Method analysis must be done using Manning's Equation. where:

$$V = (1.486/n)(R^{2/3})(S^{1/2})$$

Then:

$$Q = (V)(A)$$

Where:

- Q = capacity in cubic feet per second
- V = mean velocity of flow in feet per second
- A = cross sectional area in square feet
- R = hydraulic radius in feet
- S = slope of the energy grade line in feet per foot
- n = Manning's "n" or roughness coefficient

The hydraulic radius, R, is defined as the cross-sectional area of flow divided by the wetted flow surface or wetted perimeter. Allowable "n" values and full-flow maximum permissible velocities for storm sewer materials are listed in **Table 4-1**.

TABLE 4-1

Typical Values of Manning's "n"		
<i>Material</i>	<i>Manning's "n"</i>	<i>Maximum Velocities (feet/second)</i>
□ Closed Conduits		
Concrete	0.013	10
Vitrified Clay	0.013	10
HDPE & Polypropylene	0.012	10
PVC	0.012	10
□ Circular CMP, Annular Corrugations, 2 2/3 x 1/2 inch		
Unpaved	0.024	7
25% Paved	0.021	7
50% Paved	0.018	7
100% Paved	0.013	7
Concrete Culverts	0.013	10
HDPE or PVC	0.012	10
□ Open Channels		
Concrete, Trowel Finish	0.013	10
Concrete, Broom Finish	0.015	10
Gunite	0.018	10
Riprap Placed	0.030	10
Riprap Dumped	0.035	10
Gabion	0.028	10
New Earth (1)	0.025	4
Existing Earth (2)	0.030	4
Dense Growth of Weeds	0.040	4
Dense Weeds and Brush	0.040	4
Swale with Grass	0.035	4

Source of manning "n" values: HERPICC Stormwater Drainage Manual, July 1995.

- (1) New earth (uniform, sodded, clay soil)
- (2) Existing earth (fairly uniform, with some weeds).

C. BACKWATER METHOD FOR PIPE SYSTEM ANALYSIS

For hydraulic analysis of existing or proposed storm drains which possess submerged outfalls, a more sophisticated design/analysis methodology than Manning's equation will be required. The backwater analysis method provides a more accurate estimate of pipe flow by calculating individual head losses in pipe systems that are surcharged and/or have submerged outlets. These head losses are added to a known downstream water surface elevation to give a design water surface elevation for a given flow at the desired upstream location.

Tailwater conditions assumed for this computation should be verified by appropriate calculations. Total head losses may be determined as follows:

$$\text{Total head loss} = \text{frictional loss} + \text{manhole loss} + \text{velocity head loss} + \text{junction loss}$$

Various computer modeling programs such as HYDRA, ILLUDRAIN, and STORMCAD are available for analysis of storm drains under these conditions. Computer models to be utilized, other than those listed, must be accepted by the CCDB or designee.

D. MINIMUM SIZE FOR STORM SEWERS

The minimum diameter of all storm sewers shall be 12 inches. When the minimum 12-inch diameter pipe will not limit the rate of release to the required amount, the rate of release for detention storage shall be controlled by an orifice plate or other device, subject to acceptance of the CCDB or designee.

E. PIPE COVER, GRADE, AND SEPARATION FROM SANITARY SEWERS

Pipe grade shall be such that, in general, a minimum of 2.0 feet of cover is maintained over the top of the pipe. If the pipe is to be placed under pavement, or within 5 feet of the pavement, then the minimum pipe cover shall be 2.5 feet from top of pavement to top of pipe. Uniform slopes shall be maintained between inlets, manholes and inlets to manholes. Final grade shall be set with full consideration of the capacity required, sedimentation problems, and other design parameters. Minimum and maximum allowable slopes shall be those capable of producing velocities of between 2.5 and 10 feet per second, respectively, when the sewer is flowing full. Maximum permissible velocities for various storm sewer materials are listed in Table 4-1. A minimum of 2.0 feet of vertical separation between storm sewers and sanitary sewers shall be required. When this is not possible, the sanitary sewer must be encased in concrete or ductile steel within 5 feet, each side, of the crossing centerline.

F. ALIGNMENT

Storm sewers shall be straight between manholes and/or inlets.

G. MANHOLES/INLETS

Manholes and/or inlets shall be installed to provide human access to continuous underground storm sewers for the purpose of inspection and maintenance. The casting access minimum inside diameter shall be no less than 22 inches or a rectangular opening of no less than 22 inches by 22 inches. Steps shall be provided in structures deeper than 4 feet, with the first step at the depth of 2 feet and the following steps spaced every 1 foot until the bottom is reached. When grade adjustments of manholes and inlets are required in the field to meet finish design or existing curb grade, adjustment rings with a maximum height of 12 inches may be used. Manholes shall be provided at the following locations:

1. Where two or more storm sewers converge.
2. Where pipe size or the pipe material changes.
3. Where a change in horizontal alignment occurs.
4. Where a change in pipe slope occurs.
5. At intervals in straight sections of sewer, not to exceed the maximum allowed. The maximum distance between storm sewer manholes shall be as shown in **Table 4-2**.

TABLE 4-2

Maximum Distance Between Manholes	
Size of Pipe (Inches)	Maximum Distance (Feet)
12 through 42	400
48 and larger	600

Manhole/inlet inside sizing shall be according to the Clark County Standard Construction Details.

In addition to the above requirements, a minimum drop of 0.1 foot through manholes and inlet structures should be provided. When changing pipe size, match crowns of pipes, unless detailed modeling of hydraulic grade line shows that another arrangement would be as effective. Pipe slope should not be so steep that inlets surcharge (i.e. hydraulic grade line should remain below rim elevation).

Plans should note that all Inlets and castings must be pre-stamped with a “clean water” message.

Manhole/inlet inside sizing shall be as shown in **Table 4-3**.

TABLE 4-3

Manhole/Inlet Inside Sizing		
Depth of Structure	Minimum Diameter	Minimum Square Opening
Less than 5 feet	36 inches	36" x 36"
5 feet or more	48 inches	48" x 48"

H. INLET SIZING AND SPACING

Inlets or drainage structures shall be utilized to collect surface water through grated openings and convey it to storm sewers, channels, or culverts. The inlet grate opening provided shall be adequate to pass the design 10-year flow with 50% of the sag inlet areas clogged. Inlets shall be provided so that surface water is not carried across or around any intersection nor for a distance greater than five hundred (500) feet. An overflow channel from sag inlets to the overflow channel or basin shall be provided at sag inlets. Inlet design and spacing may be done using the hydraulic equations by manufacturers or orifice/weir equations. Use of the U.S. Army Corps of Engineers HEC-12 computer program is also an acceptable method. Gutter spread on continuous grades may be determined using the Manning's equation, or by using **Figure 4-1**. Further guidance regarding gutter spread calculation may be found in the latest edition of LTAP Stormwater Drainage Manual, available from the Local Technical Assistance Program (LTAP). At the time of printing of this document, contact information for LTAP was:

Indiana LTAP
Purdue University
Toll-Free: (800) 428-7369 (Indiana only)
Phone: (765) 494-2164
Fax: (765) 496-1176
Email: inltap@ecn.purdue.edu
Website: www.purdue.edu/INLTAP/

I. INSTALLATION AND WORKMANSHIP

The point of commencement for laying a storm sewer pipe shall be the lowest point in the proposed sewer line. All pipes shall be laid, without break, upgrade from structure to structure. All storm sewer pipe outlets shall have poured in place toewalls with anchor bolts. Bedding and backfill materials around storm sewer pipes, sub-drains, and the associated structures shall be per Figures 4-2 and 4-3. The specific location requirements for the use of these materials are dependent on pipe location in relation to pavement structures and on pipe material as detailed in **Figure 4-2** and **Figure 4-3**. The specifications for the construction of storm sewers and sub-drains, including backfill requirements, shall not be less stringent than those set forth in the latest edition of the INDOT "Standard Specifications". Additionally, ductile iron pipe shall be laid in accordance with American Water Works Association (AWWA) C-600 and clay pipe shall be laid in accordance with either American Society of Testing Materials (ASTM) C-12 or the appropriate American Association of State Highway and Transportation Officials (AASHTO) specifications.

Dips/sags on newly installed storm systems will not be allowed. Also, infiltration from cracks, missing pieces, and joints would not be allowed. Variations from these standards must be justified and receive written acceptance from the CCDB or designee. To verify that all enclosed drains and sewers are

functioning properly, all storm sewers including sub-drains shall be cleaned and televised with visual recordings (via closed circuit television). Two visual recordings will be scheduled, 30 days after installation and at least 90 days prior to the expiration of the maintenance bond. Reports summarizing the results of the noted visual recordings shall be reviewed and accepted by the CCDB or designee before maintenance sureties would be recommended to be released.

Based on the review of visual recordings, the CCDB or designee shall determine the need for additional inspection of the storm sewers or sub-drains to assess the condition of the system. Newly installed storm systems covered under the maintenance bond shall meet the minimum requirements established in the AASHTO Culvert and Storm Drain Inspection Guide constituting a Condition Rating of 1 or "Good" as defined in Section 4, Condition Rating System and as established below in **Table 4-4**.

TABLE 4-4

Pipe Inspection Criteria	
Material	(1) Good Rating Condition
HDPE, PVC or PP	Barrel maintains round shape with less than 5% vertical deformation of original ID. No indication of wear, abrasion, splits or cracking.
Concrete	No measurable crack width greater than 0.01 in. No spalling, slabbing, delamination, scaling or abrasion.
CMP	Barrel maintains round shape with less than 5% vertical deformation of inside diameter. No dents, rust, abrasion or localized damage.

J. MATERIALS

Storm sewer manholes and inlets shall be constructed of cast in place concrete or pre-cast reinforced concrete. Material and construction shall conform to the latest edition of the Indiana Department of Transportation (INDOT) "Standard Specifications", Sections 702 and 720.

Pipe and fittings used in storm sewer construction shall conform to the latest edition of the INDOT "Standard Specifications", Section 907 and 908. In addition, ductile iron pipe and fittings shall conform to AWWA C-151. Polyethylene pipe used for private storm sewers shall conform to ASTM F2648 or INDOT specifications. Other pipe and fittings not specified herein or in Sections 907-908 of the latest edition of the INDOT "Standard Specifications" may be used only when specifically authorized by the CCDB or designee. Pipe joints shall be flexible and leak resistant as defined in AASHTO R82, with a maximum leakage rate of 200 gal/in.-dia/mi/day. If the storm sewer pipe is to be placed within a road right-of-way or in an area subject to loading, the pipe and fittings shall be reinforced concrete (RCP) or corrugated polypropylene (CPP).

K. SPECIAL HYDRAULIC STRUCTURES

Special hydraulic structures required to control the flow of water in storm runoff drainage systems include junction chambers, drop manholes, stilling basins, and other special structures. The use of these structures

shall be limited to those locations justified by prudent planning and by careful and thorough hydraulic engineering analysis. Certification of special structures by a certified Structural Engineer may also be required.

L. CONNECTIONS TO STORM SEWER SYSTEM

To allow any connections to the storm sewer system, provisions for the connections shall be shown in the drainage calculations for the system. Specific language shall be provided in the protective covenants, on the record plat, or with the parcel deed of record, noting the ability or inability of the system to accommodate any permitted connections, for example, sump pumps and footing drains.

1. **Sump pumps** installed to receive and discharge groundwater or other stormwater shall be connected to a sub-surface drain provided by the developer. Sump pumps installed to receive and discharge floor drain flow or other sanitary sewage shall be connected to the sanitary sewers. A stormwater sump pump shall only be used for the discharge of stormwater.
2. **Footing drains and perimeter drains** shall be connected to the sub-surface drain provided by the developer.
3. All **roof downspouts**, roof drains, or roof drainage piping of residential developments shall discharge onto a grass surface that is no closer than 25 feet to the right-of-way of any street and shall not be directly connected to the storm drainage system. Variation from this requirement may be requested and granted by the CCDB or designee in special circumstances. No downspouts or roof drains shall be connected to the public sanitary sewers.

Commercial, industrial, and institutional buildings that have their own private storm sewers may direct such drains directly to their systems.

4. **Garage and Basement floor drains** shall not be connected to the storm sewers.
5. **Swimming Pool drains** shall not be connected to the storm sewers unless the water is dechlorinated, as defined in Appendix A, prior to being connected to the storm sewer.

In addition, none of the above-mentioned drains shall be connected to any road sub-drain/street underdrains, unless requested as a variance and specifically authorized by the CCDB or designee. Sub-drains shall be installed on all new developments by the developer.

M. DRAINAGE SYSTEM OVERFLOW DESIGN

Overflow path/ponding areas throughout the development resulting from a 100-year storm event, calculated based on all contributing drainage areas, on-site and off-site, in their proposed or reasonably anticipated land use and with storm pipe system assumed completely plugged, shall be determined,

The centerline of this 100-year overflow path shall be clearly shown as a distinctive line symbol on the plans, and a minimum width of 30 feet flow width along the centerline of the flow path (15 feet from centerline on each side) designated as permanent drainage easements. A continuous flood route from the sag inlets to the final outfall shall be shown and the minimum 30-feet along the centerline contained within an easement or road right-of-way regardless of the 100-year storm event ponding elevation. This overflow path/easement area shall be shown on the plans as hatched area or another distinctive symbol. No fences or landscaping should be constructed within the easement areas. These areas are easements that are to be maintained by the property owners or be designated as common areas to be maintained by the homeowners association.

The minimum adjacent grade of the portion of any residential, commercial, or industrial building (the ground elevation next to the building after construction is completed that sits adjacent to the emergency flood route or may be subject to flooding by the emergency flood route) shall be a minimum of 1 foot above the estimated 100-year elevation of the emergency flood route assuming that all stormwater pipes are fully clogged. The required minimum adjacent grade of buildings adjacent to an overflow path is provided in Table 4-5 or as alternatively calculated as discussed below.

TABLE 4-5

Minimum Building Adjacent Grade with Respect to Overflow Path Invert Elevations		
Drainage Area (Acres)	Minimum Building Adjacent Grade Above Overflow Path Invert (Feet)¹	Minimum Building Adjacent Grade Above Overflow Path Invert, if Overflow Path is in the Street (Feet)¹
Up to 5	2.50	1.50
6-10	3.00	1.50
11-15	3.25	1.75
16-20	3.50	1.75
21-30	4.00	2.00
30-50	4.25	2.00

Notes: ¹ The overflow path Invert refers to the elevation of the flow line of the emergency flow route (typically in the form of a channel, swale, or gutter) nearest to the upstream end of a building

As an alternative to using default values in Table 4-5, the overflow path/ponding may be modeled as successive series of natural ponds and open channel segments. For simplification, occasional ponding along the overflow path may be ignored. If explicitly modeled, ponds should be modeled similar to that discussed for modeling depressional areas in Chapter 6. Channels should be modeled according to modeling techniques discussed in Chapter 5. The calculations for determining the 100-year overflow path/ponding elevations may be based on hand calculation methods utilizing normal depth calculations and storage routing techniques or performed by computer models. Examples of computer models that either individually or in combination with other models can handle the required computations include TR-20 and HEC-HMS, combined with HEC-RAS. Other models may be acceptable on a case by case basis.

Simply using the values in Table 4-5 is preferred over the much more complicated detailed modeling of the overflow/ponding areas. However, regardless of the methodology used, the CCDB or designee reserves the right to require independent calculations to verify that the proposed building minimum adjacent grade facing the flood route or the portion of building having a potential to be subject to flooding by the flood route provide adequate freeboard above the anticipated overflow path/ponding elevations.

The Lowest Adjacent Grade (LAG) requirements for buildings adjacent to other flooding sources are discussed in Chapter 10 of this Manual. In case there are more than one flooding sources applicable to a building site, the highest calculated LAG for the building shall govern the placement of the building on that site

In the case of existing upstream detention, an allowance equivalent to the reduction in flow rate provided may be made for upstream detention only when: (1) such detention and release rate have previously been accepted by the CCDB or designee or other official charged with the approval authority at the time of the acceptance, and (2) evidence of its construction and maintenance can be shown.

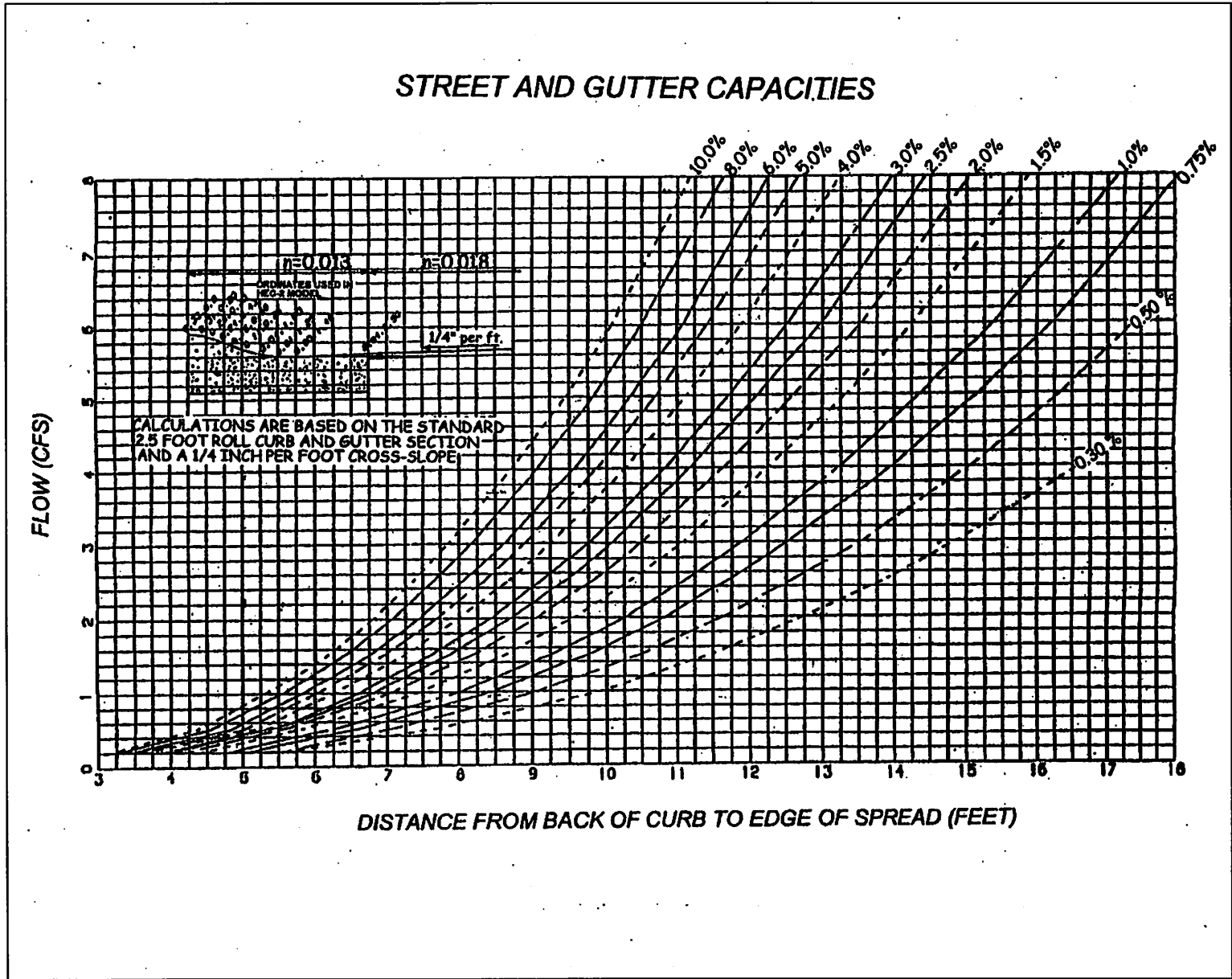

FIGURE 4-1
Street and Gutter Capacities (continuous grade)

**FIGURE 4-2
Bedding and Backfill Standards for Storm Sewers**

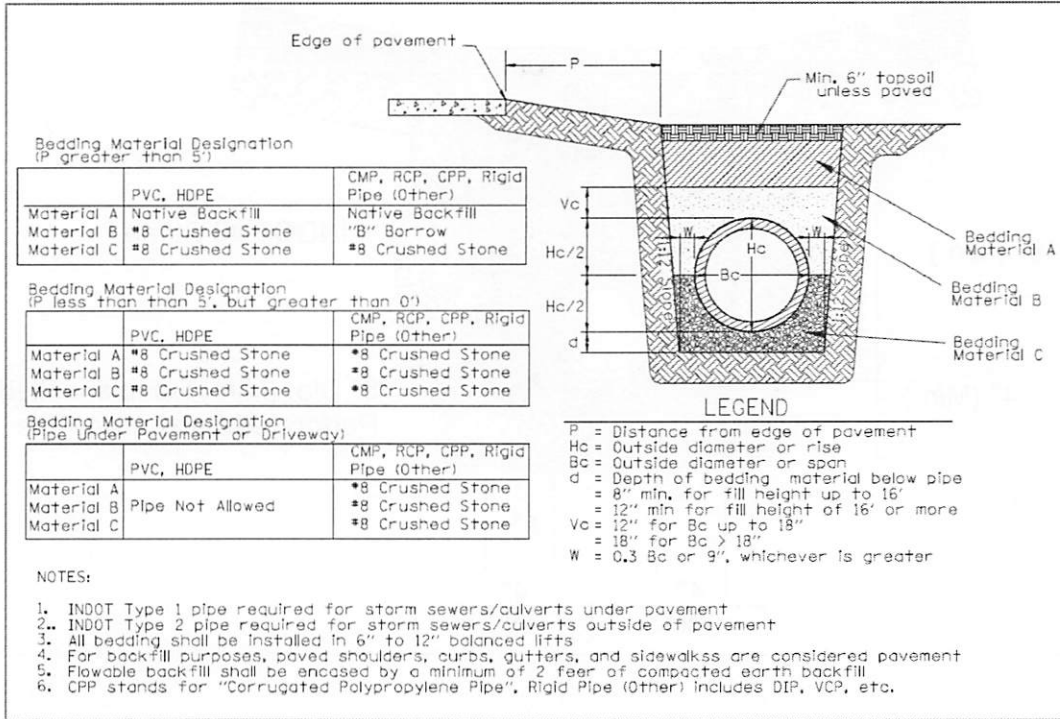
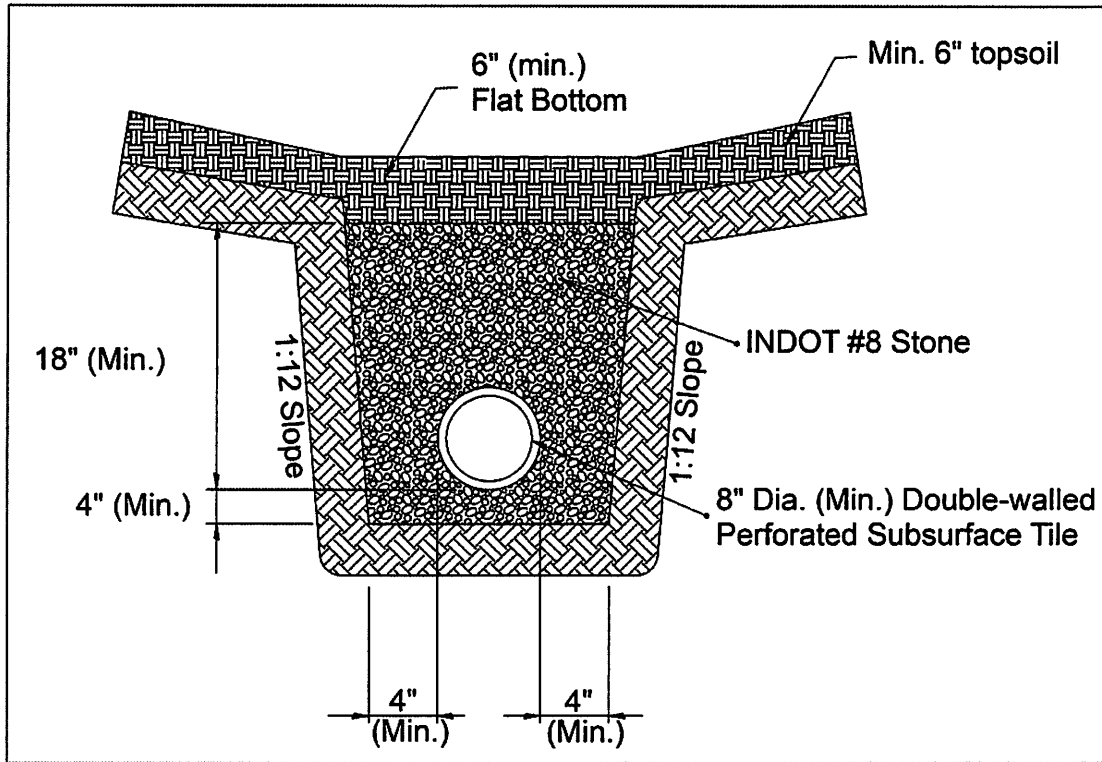

FIGURE 4-3
Bedding and Backfill Standards for Sub-drains under Swales





Chapter Five

OPEN CHANNEL DESIGN STANDARDS AND SPECIFICATIONS

All channels, whether private or public, and whether constructed on private or public land, shall conform to the design standards and other design requirements contained herein. Unless specifically referenced in a particular provision, the standards contained in this Chapter refer to open channels and not swales. Proposed open channels must be sized and designed to convey at least the 10-year frequency on-site stormwater runoff, as well as the anticipated 10-year frequency tributary off-site stormwater runoff based on the future developed condition (using Table 6-1 of the Technical Standards). An analysis of the emergency routing of stormwater runoff through the subject development must be provided to confirm that the development will not obstruct the free flow of floodwaters from the tributary off-site property in its current condition and after development. In addition, the Drainage System Overflow Design must be completed in accordance with Section M of Chapter 4 to ensure the safe routing of flood waters through the subject development with the tributary off-site property in its current condition and after development.

A. DESIGN STORM FREQUENCIES

1. All channels and swales shall accommodate, as a minimum, peak runoff from a 10-year return frequency storm calculated based on methodology described in Chapter 2.
2. Channels with a carrying capacity of more than 30 cfs at bank-full stage shall be capable of accommodating peak runoff for a 50-year return frequency storm within the drainage easement.
3. Channel facilities functioning as a major drainage system, as defined in **Appendix A**, must also meet IDNR design standards in addition to the Clark County standards. In case of discrepancy, the most restrictive requirements shall apply.
4. The 10-year storm design flow for residential rear and side lot swales shall not exceed 4 cfs. Unless designed as a Post-construction stormwater quality BMP, the maximum length of rear and side lot swales before reaching any inlet shall not exceed 400 feet.
5. Regardless of minimum design frequencies stated above, the performance of all parts of drainage system shall be checked for the 100-year flow conditions to ensure that all buildings are properly located outside the 100-year flood boundary and that flow paths are confined to designated areas with sufficient easement.
6. A minimum of 25 feet from top of the bank on each side of a new channel shall be designated on the recorded plat as a Drainage Easement. No landscaping is allowed within any Drainage Easement, except for a minimum 25-foot width of filter strip or suitable grass that shall be installed along the top of bank.

B. DETERMINATION OF CHANNEL WATERWAY AREA USING MANNING'S EQUATION

The waterway area for channels shall be determined using Manning's Equation, where:

$$A = Q/V$$

A = Waterway area of channel in square feet

Q = Discharge in cubic feet per second (cfs)

V = Steady-State channel velocity, as defined by Manning's Equation (See Chapter 4)

C. BACKWATER METHOD FOR DRAINAGE SYSTEM ANALYSIS

The determination of 100-year water surface elevation along channels and swales shall be based on accepted methodology and computer programs designed for this purpose. Computer programs HEC-RAS, HEC-2, and ICPR are preferred programs for conducting such backwater analysis. The use of other computer models must be accepted in advance by the CCDB or designee.

D. CHANNEL CROSS-SECTION AND GRADE

1. The required channel cross-section and grade are determined by the design capacity, the material in which the channel is to be constructed, and the requirements for maintenance. A minimum depth may be required to provide adequate outlets for subsurface drains, tributary ditches, or streams. The channel grade shall be such that the velocity in the channel is high enough to prevent siltation but low enough to prevent erosion. Velocities less than 2 feet per second for the design storm are not acceptable, as siltation will take place and ultimately reduce the channel cross-section area. The maximum permissible velocities in vegetated-lined channels are shown in **Table 5-1**. In addition to existing runoff, the channel design should incorporate increased runoff due to the proposed development.
2. Where depth of design flow is slightly below critical depth, channels shall have freeboard adequate to cope with the effect of hydraulic jumps.
3. Along the streets and roads, the bottom of the ditch should be low enough to install adequately sized driveway culverts without creating "speed bumps". The driveway culvert inverts shall be designed to adequately consider upstream and downstream culvert elevations. Use of open channels and swales within the road right of way is only allowed in special circumstances when no other viable option exists. The applicant must consult with the Clark County Engineer prior to design.
4. Flow of a channel into a closed system is prohibited, unless runoff rate and head loss computations demonstrate the closed conduit to be capable of carrying the 100-year channel flow for developed conditions, either entirely or in combination with a defined overflow channel, with no reduction of velocity.

TABLE 5-1

Maximum Permissible Velocities in Vegetal-Lined Channels (1)			
<i>Cover</i>	<i>Channel Slope Range (Percent) (3)</i>	<i>Permissible Velocity (2)</i>	
		<i>Erosion Resistant Soils (ft. per sec.) (4)</i>	<i>Easily Eroded Soils (ft. per sec.) (4)</i>
Bermuda Grass	0-5 5-10 Over 10	8 7 6	6 5 4
Bahia Buffalo Grass Kentucky Bluegrass Smooth Brome Blue Grama	0-5 5-10 Over 10	7 6 5	5 4 3
Grass Mixture Reed Canary Grass	(3) 0-5 5-10	5 4	4 3
Lespedeza Sericea Weeping Lovegrass Yellow Bluestem Redtop Alfalfa Red Fescue	(4) 0-5 5-10	3.4	2.5
Common Lespedeza (5) Sudangrass (5)	(6) 0-5	3.5	2.5

- (1) From Soil Conservation Service, SCS-TP-61, "Handbook of Channel Design for Soil and Water Conservation".
- (2) Use velocities exceeding 5 feet per second only where good channel ground covers and proper maintenance can be obtained.
- (3) Do not use on slopes steeper than 10 percent except for vegetated side slopes in combination with a stone, concrete, or highly resistant vegetative center section.
- (4) Do not use on slopes steeper than 5 percent except for vegetated side slopes in combination with a stone, concrete, or highly resistant vegetative center section.
- (5) Annuals - use on mild slopes or as temporary protection until permanent covers are established.
- (6) Use on slopes steeper than 5 percent is not recommended.

E. SIDE SLOPES

1. Earthen channel side slopes shall be no steeper than 3 horizontal to 1 vertical (3:1). Flatter slopes may be required to prevent erosion and for ease of maintenance.
2. Where channels will be lined with riprap, concrete, or other acceptable lining method, side slopes shall be no steeper than 2 horizontal to 1 vertical (2:1) with adequate provisions made for weep holes.
3. Side slopes steeper than 2 horizontal to 1 vertical (2:1) may be used for lined channels provided that the side lining is designed and constructed as a structural retaining wall with provisions for live and dead load surcharge.

4. When the design discharge produces a depth of greater than three (3) feet in the channel, appropriate safety precautions shall be added to the design based on reasonably anticipated safety needs at the site.

F. CHANNEL STABILITY

1. Characteristics of a stable channel are:
 - a. It neither promotes sedimentation nor degrades the channel bottom and sides.
 - b. The channel banks do not erode to the extent that the channel cross-section is changed appreciably.
 - c. Excessive sediment bars do not develop.
 - d. Excessive erosion does not occur around culverts, bridges, outfalls or elsewhere.
 - e. Gullies do not form or enlarge due to the entry of uncontrolled flow to the channel.
2. Channel stability shall be determined for an aged condition and the velocity shall be based on the design flow or the bankfull flow, whichever is greater, using an "n" value for various channel linings as shown in **Tables 4-1 and 5-1**. In no case is it necessary to check channel stability for discharges greater than that from a 100-year frequency storm.
3. Channel stability shall be checked for conditions representing the period immediately after construction. For this stability analysis, the velocity shall be calculated for the expected flow from a 10-year frequency storm on the watershed, or the bankfull flow, whichever is smaller, and the "n" value for the newly constructed channels in fine-grained soils and sands may be determined in accordance with the "National Engineering Handbook 5, Supplement B, Soil Conservation Service" and shall not exceed 0.025. The allowable velocity in the newly constructed channel may be increased by a maximum of 20 percent to reflect the effects of vegetation to be established under the following conditions:
 - a. The soil and site in which the channel is to be constructed are suitable for rapid establishment and support of erosion controlling vegetation.
 - b. Species of erosion controlling vegetation adapted to the area, and proven methods of establishment are shown.
 - c. The channel design includes detailed plans for establishment of vegetation on the channel side slopes.

G. DRAINAGE OF SWALES

All swales shall meet the following requirements and the specifications of the CCDB or designee:

1. Minimum swale flow line slopes are 1%. Swales with longitudinal slopes that are flatter than 1% shall consist of 6-inch thick rebar-reinforced concrete. The side slopes of swales shall not be steeper than a 4 (horizontal) to 1 (vertical) slope.
2. Maximum swale flow line slopes are 7%.
3. Minimum swale top width shall be 6 feet.
4. All flow shall be confined to the specific easements associated with each rear and side lot swale that are part of the minor drainage system.

5. Unless designed to act as a stormwater quality BMP or lined with concrete, vegetated swales shall have a double-walled 8-inch sub-surface drain with a minimum cover of 18 inches to dry the swales. Typical detail of a swale with sub-surface drain is shown on Figure 4-3. Tile lines may be outletted through a drop structure at the ends of the swale or through a standard tile outlet. Before reaching an open channel, the perforated drain shall be connected to 10 feet of SDR # 40. Also, cleanout risers are to be installed at the high point as well as end of run.
6. A minimum of 20 feet along the swale (10 feet from each side of the centerline) must be designated on the recorded plat as Drainage Easement.
7. Further guidance regarding this subject may be found in the latest edition of the Indiana Drainage Handbook.

H. APPURTENANT STRUCTURES

The design of channels will include provisions for operation and maintenance and the proper functioning of all channels, laterals, travelways, and structures associated with the project. Recessed inlets and structures needed for entry of surface and subsurface flow into channels without significant erosion or degradation shall be included in the design of channel improvements. The design will also provide for necessary floodgates, water level control devices, and any other appurtenance structure affecting the functioning of the channels and the attainment of the purpose for which they are built.

The effects of channel improvements on existing culverts, bridges, buried cables, pipelines, and inlet structures for surface and subsurface drainage on the channel being improved and laterals thereto shall be evaluated to determine the need for modification or replacement. Culverts and bridges which are modified or added as part of channel improvement projects shall meet reasonable standards for the type of structure, and shall have a minimum capacity equal to the design discharge or governmental agency design requirements, whichever is greater.

I. DISPOSAL OF SPOIL

Spoil material resulting from clearing, grubbing, and channel excavation shall be disposed of in a manner that will:

1. Minimize overbank wash.
2. Provide for the free flow of water between the channel and floodplain boundary unless the valley routing and water surface profiles are based on continuous dikes being installed.
3. Not hinder the development of travelways for maintenance.
4. Leave the right-of-way in the best condition feasible, consistent with the project purposes, for productive use by the owner.

J. MATERIALS

Materials acceptable for use as channel lining are:

1. Grass
2. Revetment Riprap

3. Concrete
4. Hand Laid Riprap
5. Precast Cement Concrete Riprap
6. Gabions
7. Straw, Coconut Mattings, or other accepted material (only until grass is established)

Other lining materials must be accepted in writing by the CCDB or designee. Materials shall comply with the latest edition of the INDOT, "Standard Specifications".

K. DRAINAGE SYSTEM OVERFLOW DESIGN

See Chapter 4, Section M.



Chapter Six

STORMWATER DETENTION DESIGN STANDARDS FOR PEAK FLOW CONTROL

Basins shall be constructed to retain and/or temporarily detain the stormwater runoff that exceeds the maximum peak release rate authorized by the Ordinance and these technical standards. The required volume of storage provided in these basins, together with such storage as may be authorized in other on-site facilities, shall be sufficient to control excess runoff from the 10-year or 100-year storm as explained below in Section "B.". Also, basins shall be constructed to provide adequate capacity to allow for sediment accumulation resulting from development and to permit the pond to function for reasonable periods between cleanings.

A. SUGGESTED CALCULATION SEQUENCES FOR DESIGNING A DETENTION POND FOR PEAK FLOW CONTROL

In addition to the requirement for peak flow control through retention and/or detention, the Stormwater Management Ordinance and Technical Standards require the developer to address Channel Protection and Water Quality Control requirements discussed in Chapter 8. The proper way to accommodate the water quality, channel protection, and peak flow rate control of a site is to first consider addressing the water quality and channel protection volume requirements through conventional or LID approaches (as described in Chapter 8) and then determine the size and dimensions of the required retention or detention storage for peak flow rate control.

Chapter 8 provides several BMPs and options to address the channel protection volume and water quality requirements. However, in many cases, providing some level of extended detention may become necessary to meet those requirements. While such extended detention is best provided in a separate facility, many developers choose to combine the needed extended detention feature with the detention pond needed for peak runoff rate control of the site into one facility.

A combined facility must accommodate the channel protection volume, water quality volume, and design storm detention to meet allowable release rate requirements while also meeting channel protection or water quality detention time requirements.

These requirements can be challenging to meet, especially with additional considerations needed for bypassing runoff from off-site areas. The following are suggested calculation sequences for designing a detention pond for peak flow control only, and for combining extended detention with peak flow control. However, every site is different and depending on the site conditions and the layout of the pond, there may be other ways to design the pond such that all the pond's objectives are met.

Peak Flow Control Only

1. Determine the main outlet's control elevation.
2. Route the on-site 10-year and 100-year inflow hydrographs through the pond (by temporarily ignoring off-site flows) and size the main outlet to limit peak outflows to the allowable release rates. If an orifice will need to be used to limit the outflow, use the actual orifice size needed to meet the release rate requirements, unless the calculated diameter is less than 6 inches, in which case the minimum 6-inch orifice diameter shall be used. The resulting maximum water surface elevation is the top of peak flow control storage for on-site flows. If no off-site flows are routed through the detention facility, then this

will be the pond's 100-year elevation and the emergency spillway invert elevation is also set at this elevation.

3. Off-site flows that are bypassed (no detention) through the site detention pond (rather than bypassed around the pond), should be routed through a separate outlet (such as a drop inlet structure) with its control elevation set at the on-site 100-year pond elevation determined in Step 2. The 100-year pond elevation is determined by routing the on-site and off-site 100-year inflow hydrographs through the pond. Ideally, a separate emergency spillway should be provided with an invert elevation set at the combined (on-site and off-site) 100-year ponding elevation. A less desirable option would be to route the off-site flows through the emergency spillway with the invert elevation set at the on-site 100-year ponding elevation as determined in Step 2. However, since this would result in water flowing over the emergency spillway more frequently, this option may require additional erosion control measures based on the estimated frequency of use. Additional discussion on managing off-site runoff is contained in Section C.3 of this chapter.

Combined Peak Flow Control and Extended Detention

1. Calculate the extended detention storage volume as needed to address the requirements noted in Chapter 8. Also, note that there may be no need to provide extended detention, depending on the approach used to address water quality and channel protection volume requirements.
2. Determine the outlet control elevation. This will be the bottom of the extended detention storage volume, and the permanent pool elevation if a wet-bottom pond is used.
3. Design the pond to provide the extended detention storage volume determined in Step 1, and assuming no outflow through the pond outlet. The top of this storage volume will be the invert elevation of the main outlet.
4. Route the on-site 10-year and 100-year inflow hydrographs through the pond (with the initial elevation at normal pool, i.e., the bottom of extended detention space) and size the main outlet to limit peak outflows to the allowable release rates. If an orifice will need to be used to limit the outflow, use the actual orifice size needed to meet the release rate requirements, unless the calculated diameter is less than 6 inches, in which case the minimum 6-inch orifice diameter shall be used. The resulting maximum water surface elevation is the top of peak flow control storage for on-site flows. If no off-site flows are routed through the detention facility, then this will be the pond's 100-year elevation and the emergency spillway invert elevation is also set at this elevation.
5. Off-site flows that are bypassed (no detention) through the site detention pond (rather than bypassed around the pond), should be routed through a separate outlet (such as a drop inlet structure) with its control elevation set at the on-site 100-year pond elevation determined in Step 2. The 100-year pond elevation is determined by routing the on-site and off-site 100-year inflow hydrographs through the pond. Ideally, a separate emergency spillway should be provided with an invert elevation set at the combined (on-site and off-site) 100-year ponding elevation. A less desirable option would be to route the off-site flows through the emergency spillway with the invert elevation set at the on-site 100-year ponding elevation as determined in Step 2. However, since this would result in water flowing over the emergency spillway more frequently, this option may require additional erosion control measures based on the estimated frequency of use. Additional discussion on managing off-site runoff is contained in Section C.3 of this chapter.
6. Determine the size and design the retention/extended detention storage drain in a manner to meet the extended detention minimum and maximum emptying time requirements discussed in Chapter 8, using both on-site and, if applicable, off-site runoff. If an orifice is required to control the flow of the extended detention drain, the minimum orifice size shall be 6 inches. However, depending on the proposed clog-

free design and the proposed maintenance schedule of the extended detention storage drain structures, a smaller orifice than 6 inches may be allowed on a case by case basis.

7. To make sure that the addition of the release through the drain will not cause the on-site only allowable release rate to be exceeded, reroute the on-site 10-year and 100-year inflow hydrographs through the pond (with the initial elevation at normal pool, i.e., the bottom of extended detention space), this time allowing water to also leave through the extended detention storage drain as the pond fills up. If the total peak outflow discharge exceeds the on-site only allowable release rate, the size of the main outlet orifice may need to be reduced or the storage volume increased.

Note that in some instances such as relatively small development sites less than 10 acres or sites with highly restrictive site-specific maximum allowable release rates, when the required outlet orifice size and/or the required size of the extended detention drain will be small, the calculated drain time may extend beyond the maximum required 48-hour emptying time. Often times, the situation can be addressed through enlarging the pond volume or reconfiguring the pond's shape. When the situation cannot be resolved in a reasonable manner despite those attempts, the CCDB or designee may, on a case by case basis, allow deviation from the required orifice size, maximum allowable release, or emptying time after considering reasonable options and examining the potential impacts on downstream or upstream areas. Economic factors shall not be considered for this determination.

The following shall govern the design of any improvement with respect to the retention/detention of stormwater runoff for peak flow control.

B. ACCEPTABLE DETENTION FACILITIES

The increased stormwater runoff resulting from a proposed development should be retained (if possible) and detained on-site (if retention is not feasible due to limited infiltration capacity) by the provisions of appropriate above- or below-ground wet bottom or dry bottom detention facilities, parking lots, or other acceptable techniques. Measures that retard the rate of overland flow and the velocity in runoff channels shall also be used to partially control runoff rates.

C. ALLOWABLE RELEASE RATES

1. General Release Rates

Control devices shall limit the discharge to a rate such that the post-developed release rate from the site is no greater than 0.x cfs per acre of development for 0 - 10 year return interval storms and 0.x cfs per acre of developed area for 11 - 100 year return interval storms. The above fixed general release rates may be set at a lower value by the CCDB or designee for geographical areas determined as Impact Drainage Area or for certain watersheds if more detailed data becomes available as a result of comprehensive watershed studies conducted and/or formally approved and adopted by the CCDB or designee. The applicant shall confirm the applicable release rates with the CCDB or designee prior to initiating the design calculations to determine whether a basin-specific release rate has been established for the watershed of their interest or whether the site is located within a designated or an Impact Drainage Area.

For sites where the pre-developed area has more than one (1) outlet, the release rate should be computed based on pre-developed discharge to each outlet point. The computed release rate for each outlet point shall not be exceeded at the respective outlet point even if the post developed conditions would involve a different arrangement of outlet points.

2. Site-Specific Release Rates for Sites with Depressional Storage

For sites where depressional storage exists, the general release rates provided above may have to be further reduced. If depressional storage exists at the site, site-specific release rates must be calculated according to methodology described in Chapter 2, accounting for the depressional storage by modeling it as a pond whose outlet is a weir at an elevation that stormwater can currently overflow the depressional storage area. Post developed release rate for sites with depressional storage shall be the 2-year pre-developed peak runoff rate for the post-developed 10-year storm and 10-year pre-developed peak runoff rate for the post-developed 100-year storm. In no case shall the calculated site-specific release rates be larger than general release rates provided above.

Note that by definition, the depressional storage does not have a direct gravity outlet but if in agricultural production, it is more than likely drained by a tile and should be modeled as "empty" at the beginning of a storm. The function of any existing depressional storage should be modeled using an event hydrograph model to determine the volume of storage that exists and its effect on the existing site release rate. To prepare such a model, certain information must be obtained, including delineating the tributary drainage area, the stage-storage relationship and discharge-rating curve, and identifying the capacity and elevation of the outlet(s).

The tributary area should be delineated on the best available topographic data. After determining the tributary area, a hydrologic analysis of the watershed should be performed, including, but not limited to, calculation of the appropriate composite runoff curve number and time of concentration. Stage-storage data for the depressional area should be obtained from the site topography. The outlet should be clearly marked, and any calculations performed to create a stage-discharge rating curve must be included with the stormwater submittal.

Also note that for determining the post-developed peak runoff rates, the depressional storage must be assumed to be filled unless the CCDB or designee can be assured, through dedicated easement, that the noted storage will be preserved in perpetuity.

3. Management of Off-site Runoff

Runoff from all upstream tributary areas (off-site land areas) may be bypassed around the retention/detention facility without attenuation. Such runoff may also be routed through the detention/retention facility, provided that a separate outlet system or channel is incorporated for the safe passage of such flows, i.e., not through the primary outlet of a detention facility.

Note that the efficiency of the retention/detention facility in controlling the on-site runoff may be severely affected if the off-site area is considerably larger than the on-site area. As a general guidance, on-line detention may not be effective in controlling on-site runoff where the ratio of off-site area to on-site area is larger than 5:1. Additional detention (above and beyond that required for on-site area) may be required by the CCDB or designee when the ratio of off-site area to on-site area is larger than 5:1.

4. Downstream Restrictions

In the event the downstream receiving channel or storm sewer system is inadequate to accommodate the post-developed release rate provided above, then the allowable release rate shall be reduced to that rate permitted by the capacity of the receiving downstream channel or storm sewer system. Additional detention, as determined by the CCDB or designee, shall be required to store that portion of the runoff exceeding the capacity of the receiving sewers or waterways. When such downstream restrictions are suspected, the CCDB or designee may require additional analysis to determine the receiving system's limiting downstream capacity.

If the proposed development makes up only a portion of the undeveloped watershed upstream of the limiting restriction, the allowable release rate for the development shall be in direct proportion to the ratio of its drainage area to the drainage area of the entire watershed upstream of the restriction.

As an alternative to reduction of release rates, the CCDB or designee may require the applicant to pursue alleviating downstream restrictions. The applicant would be responsible for obtaining all permits and consents required and for incurring all expenses involved in such undertaking.

5. Documentation of Results

The results of the allowable release rate determinations (if retaining the entire required peak flow rate volume is not feasible) as well as the modeling simulation results must be summarized in a table that shall be included in the Stormwater Drainage Technical Report and on the Drainage Plan. The table must include, for each eventual site outlet, the pre-developed acreage tributary to each eventual site outlet, the unit discharge allowable release rate used, the resulting allowable release rate in cfs for the post-developed 10-year and 100-year events, pre-developed 2-year flow rates in cfs as well as pre- and post-developed flow rates for 2-, 10-, and 100-year events. The worksheet provided as Table 6-1 should be filled for each final site outlet.

TABLE 6-1

SITE OUTLET #	ITEM	PRE-DEVELOPMENT					POST-DEVELOPMENT				
		D.A. (ac)	Depress. Storage? (yes/no)	2-Yr.	10-Yr.	100- Yr.	D.A. (ac)	Depress. Storage? (yes/no)	2-Yr.	10-Yr.	100- Yr.
1	Default Unit Discharge Allowable Release Rate (cfs/acre)									0.x	0.x
	Basin-Specific Unit Discharge Allowable Release Rate, if any (cfs/acre)										
	Unit Discharge Allowable Release Rate Based on D/S Restrictions, if any (cfs/acre)										
	Adopted Unit Discharge Allowable Release Rate (cfs/acre)										
	Contributing Area of Development Site (ac) and Allowable Release Rate (cfs)										
	Total Contributing DA (ac) and Modeling Results (cfs)							no			

D. GENERAL DETENTION BASIN DESIGN REQUIREMENTS

1. The retention/detention facility shall be designed in such a manner that a minimum of 90% of the maximum volume of water stored and subsequently released at the design release rate (if not retaining the entire peak flow rate volume) shall not result in a storage duration in excess of 48 hours from the start of the storm unless additional storms occur within the period. In other words, the design shall ensure that a minimum 90% of the original retention/detention capacity is restored within 48 hours from the start of the design 100-year storm.
2. The 100-year elevation of stormwater retention/detention facilities shall be separated by not less than 25 feet from any building or structure to be occupied. The Lowest Adjacent Grade (including walkout basement floor elevation) for all residential, commercial, or industrial buildings shall be set a minimum of 2 feet above the 100-year pond elevation or 2 feet above the emergency overflow weir elevation, whichever is higher. In addition to the Lowest Adjacent Grade requirements, any basement floor must be at least a foot above the normal water level of any wet-bottom pond or the local groundwater table, whichever is higher, to avoid the overuse of sump pumps and frequent flooding of the basement.
3. No detention facility or other water storage area, permanent or temporary, shall be constructed under or within twenty (20) feet of any pole or high voltage electric line. Likewise, poles or high voltage electric lines shall not be placed within twenty (20) feet of any detention facility or other water storage area.
4. Detention facilities shall be separated from parking lots and roadways by an appropriately-selected and designed method of safety barrier, such as guard rails, bollards, or other physical barriers capable of preventing the passage of a vehicle into the pond.
5. Slopes no steeper than 3 horizontal to 1 vertical (3:1) for safety, erosion control, stability, and ease of maintenance shall be permitted.
6. Safety screens having a maximum opening of six (6) inches shall be provided for any pipe or opening end sections 12-inch in diameter or larger. Storm drain pipes outletting into the pond shall not be submerged.
7. Use of fences around all retention/detention ponds is encouraged to assure safety. Unless specifically required by the CCDB or designee, the decision to use fencing around retention/detention ponds are left to the owner or the developer. Recommendations contained within this document do not relieve the applicant and owner/developer from the responsibility of taking all necessary steps to ensure public safety with regards to such facilities.
8. Outlet control structures shall be designed to operate as simply as possible and shall require little or no maintenance and/or attention for proper operation. For maintenance purposes, the outlet from the pond (if any) shall be a minimum of 0.5 foot above the normal water level of the receiving water body. They shall limit discharges into existing or planned downstream channels or conduits so as not to exceed the predetermined maximum authorized peak flow rate. If an outlet control structure includes an orifice to restrict the flow rate, such orifice shall be no less than 6 inches in diameter.
9. Emergency overflow facilities such as a weir or spillway shall be provided for the release of exceptional storm runoff or in emergency conditions should the normal discharge devices become totally or partially inoperative. The overflow facility shall be of such design that its operation is automatic and does not require manual attention.

Emergency overflow facilities shall be designed to convey, without overtopping the detention facility banks, one and one-quarter (1.25) times the peak inflow discharge resulting from the 100-year design storm event runoff from the entire contributing watershed draining to the detention/retention facility, assuming post-development condition on-site and existing condition off-site. The length of the weir is

to be determined using the weir equation, with the overflow weir control elevation at the Pond's 100-year elevation (pond is assumed full to the overflow weir control elevation), discharge equal to 1.25 times the peak 100-year inflow, and the maximum head being the difference between the weir control elevation and the top of the bank.

The emergency overflow routing from the emergency overflow facility to an adequate receiving system must be positive (by gravity) and shown on the construction plans. It must be sized to accommodate the design flow of the pond's emergency overflow weir. A minimum of thirty (30) feet width along the centerline of this emergency overflow route or the flow width required to accommodate the emergency spillway design flow, whichever is greater, shall be designated as permanent drainage easement. This emergency overflow path/easement area shall be shown on the plans as hatched area or another distinctive symbol. No fences or landscaping can be constructed within the easement areas. The Lowest Adjacent Grade of all residential, commercial, or industrial buildings along this emergency overflow route shall be set a minimum of 2 feet above the flood elevation along the route, calculated based on the pond's emergency overflow weir design discharge.

10. Grass or other suitable vegetative cover shall be provided along the banks of the retention/detention storage basin. Vegetative cover around detention facilities should be maintained as appropriate.
11. Debris and trash removal and other necessary maintenance shall be performed on a regular basis to assure continued operation in conformance to design.
12. No residential lots or any part thereof shall be used for any part of a detention basin assumed full to the 100-year water surface elevation or the emergency overflow weir elevation, whichever is higher. Detention basins, assumed full to the 100-year water surface elevation or the emergency overflow weir elevation, whichever is higher, shall be placed within a common area either platted or legally described and recorded as a perpetual stormwater easement.
13. A minimum of twenty (20) feet horizontally from the top of bank of the facility, or the 100-year pool if no defined top of bank is present, shall be dedicated as permanent stormwater easement if the above-noted boundary of the common area does not extend that far. Within this easement area, no trees shall be planted within 50 feet of any pipe outlet entering the pond or the outlet for the pond.

In addition, an exclusive easement to assure access to the pond from an adjacent public street/road right of way shall be required. No above-ground utilities or other obstruction that may hinder access shall be allowed within this exclusive access easement. Additional access easements may be required for larger ponds,

E. ADDITIONAL REQUIREMENTS FOR WET-BOTTOM FACILITY DESIGN

Where part of a detention facility will contain a permanent pool of water, all the items required for detention storage shall apply. Also, a controlled positive outlet will be required to maintain the design water level in the wet bottom facility and provide required detention storage above the design water level. However, the following additional conditions shall apply:

1. Facilities designed with permanent pools or containing permanent lakes shall have a water area of at least one-half (0.5) acre with a minimum depth of eight (8) feet over the majority of pond area. If fish are to be used to keep the pond clean, a minimum depth of approximately ten (10) feet shall be maintained over at least 25 percent of the pond area. The remaining pond area shall have no extensive shallow areas, except as required to install the safety ramp, safety ledge, and BMPs as required below. Construction trash or debris shall not be placed within the permanent pool.

2. All wet detention/retention ponds must be constructed in as natural a shape (footprint) as possible and have a vegetated safety ledge (approximately 6 inches below normal pool) and/or have native vegetation planted on the pond banks to create a riparian buffer (minimum 10 feet wide). Native vegetation can be installed as container grown plants or as seed at the time of construction. If native vegetation is planted on the pond banks, signage must be provided indicating that it is a natural "Do Not Mow" area. The vegetation should be planted in a manner so as not to hide or disguise the ponds edge. Maintenance of the vegetated barrier shall be the responsibility of the owner or the homeowners' association. All pond slopes shall be 3:1 (horizontal to vertical) or flatter.
3. For wet-bottom facilities without a security fence, a maintenance ledge ten (10) feet in width is required and shall be installed approximately 12 inches above the permanent water level and a safety ledge ten (10) feet in width is required and shall be installed approximately 6 inches below the permanent water level. If a non-vegetated safety ledge is installed, the depth of the safety ledge shall be approximately 18 inches below normal pool. The slope between the two ledges shall be stable and protected from erosion with hard armoring or bioengineered techniques.

For wet-bottom facilities with a security fence, a maintenance ledge six (6) feet in width is required and shall be installed approximately 12 inches above the permanent water level and a safety ledge six (6) feet in width is required and shall be installed approximately 6 inches below the permanent water level. If a non-vegetated safety ledge is installed, the depth of the safety ledge shall be approximately 18 inches below normal pool. The slope between the two ledges shall be stable and protected from erosion with hard armoring or bioengineered techniques.

The maintenance ledge may be waived if pond side slopes above normal water are 6:1 or flatter.

4. Prior to final acceptance of construction and release of bonds, danger signs warning of deep water, possible flood conditions during storm periods, or other dangers, shall be installed at an interval of 400 feet around the perimeter of wet-bottom facilities without a vegetated safety ledge, riparian buffer, or a security fence. Maintenance of the warning signs shall be the responsibility of the owner or the homeowners' association.
5. If a retaining wall is used below the normal pool of wet detention pond, the wall shall have either steps or a ladder incorporated into the construction at the center of the wall span.
6. A safety ramp exit from the lake shall be required in all cases and shall have a minimum width of twenty (20) feet and exit slope of 6 horizontal to 1 vertical (6:1). The safety ramp shall be constructed of suitable material to prevent structural instability due to vehicles or wave action. Adequate access to the safety ramp shall be provided by locating it adjacent to public right-of-way or by providing a clear route recorded within an access easement or a common area.
7. In addition to provisions specified in Section C.4 of this Chapter (if applicable), parks, playgrounds, and athletic fields shall be separated from all stormwater detention facilities by no less than 100 feet, measured from the 100-year pool of the pond. Trails and sidewalks shall be separated from all stormwater detention facilities by no less than 25 feet, measured from the 100-year pool of the pond.
8. Periodic maintenance is required in lakes to control weed and larval growth. The facility shall also be designed to provide for the easy removal of sediment that will accumulate during periods of reservoir operation. A means of maintaining the designed water level of the lake during prolonged periods of dry weather may also be required.
9. For maintenance purposes, the outlet of storm sewers entering the pond shall be a minimum of 0.5 foot above the normal pool level.

10. Methods to prevent pond stagnation, including but not limited to surface or sub-surface aeration or destratification facilities that can, at the minimum, achieve one complete pond volume turnover per day should be considered. Figure below shows a typical diffuser aeration system that consists of a quiet air compressor at the shore, aeration tubing, and one or more sets of diffuser head(s).

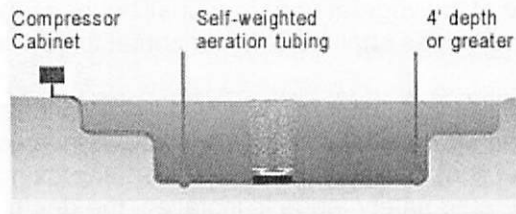

Irregularly shaped ponds should be treated as two or three separate ponds. Likewise, larger ponds will also need multiple aeration units.

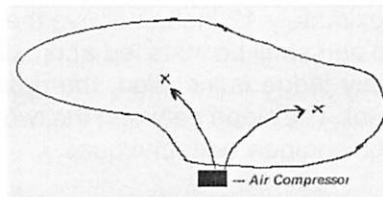

Design calculations to substantiate the effectiveness of proposed aeration facilities shall be submitted with final engineering plans. Design calculations should, at a minimum, indicate that the device and/or series of devices are providing a minimum volume turnover of once per 24 hours over the majority of the pond volume (i.e. pump radius of influence calculations, etc.). Agreements for the perpetual operation and maintenance of aeration facilities by the property owner or the HOA shall be prepared similar to that noted for post-construction BMPs noted in Chapter 8 of these Technical Standards.

If the detention pond is also proposed to be used as a post-construction stormwater BMP, alternative means of aeration (such as diffuser aeration systems) shall be used that would not result in re-suspension of sediment particles and would not prevent the efficient settling of sediment particles.

11. If the facility is being located near an airport, a minimum horizontal separation distance between the airport property and the pond will need to be provided in accordance to Federal Aviation Administration (FAA) advisory Circular 150/5200-33, titled "Hazardous Wildlife Attractions On or Near Airports" and dated 8/28/2007, or the latest update of the same.

F. ADDITIONAL REQUIREMENTS FOR DRY-BOTTOM FACILITY DESIGN

In addition to general design requirements, retention/detention facilities that will not contain a permanent pool of water shall comply with the following requirements:

1. Provisions shall be incorporated into facilities for complete interior drainage of dry bottom facilities, including the provisions of natural grades to outlet structures (if any), longitudinal and transverse grades to perimeter drainage facility. Unless designed as a retention facility, a 6-inch underdrain with a minimum of 1.5 feet of cover shall be provided within all dry-bottom ponds.
2. For residential developments, unless the facility is fully fenced in and gated, the maximum planned depth of stormwater stored shall not exceed four (4) feet.

3. In excavated retention/detention facilities, a minimum side slope of 3:1 shall be provided for stability. In the case of valley storage, natural slopes may be considered to be stable.

G. DETENTION FACILITIES IN FLOODPLAINS

No detention facilities are allowed within FEMA regulatory floodplains.

H. JOINT DEVELOPMENT OF CONTROL SYSTEMS

Stormwater control systems may be planned and constructed jointly by two or more developers as long as compliance with this Ordinance is maintained.

I. DIFFUSED OUTLETS

When the allowable runoff is released in an area that is susceptible to flooding or erosion, the developer may be required to construct appropriate storm drains through such area to avert increased flood hazard caused by the concentration of allowable runoff at one point instead of the natural overland distribution. The requirement of diffused outlet drains shall be at the discretion of the CCDB or designee.

J. IDNR REQUIREMENTS

Any construction in the floodway of a stream with a drainage area of one square mile or more must satisfy IDNR permit requirements.

K. ALLOWANCE FOR SEDIMENTATION

Retention/detention basins shall be designed with an additional ten (10) percent of available capacity to allow for sediment accumulation resulting from development and to permit the pond to function for reasonable periods between cleanings. Basins should be designed to collect sediment and debris in specific locations, such as a forebay, so that removal costs are kept to a minimum. For wet-bottom ponds, the sediment allowance may be provided below the permanent pool elevation. No construction trash or debris shall be allowed to be placed within the permanent pool. If the pond is used as a sediment control measure during active construction, the performance sureties will not be released until sediment has been cleaned out of the pond and elevations and grades have been reestablished as noted in the accepted plans.

L. MAINTENANCE

The routine maintenance of stormwater detention facilities (i.e. trash pickup, aeration, weed control, sediment removal, etc.) is the responsibility of the Homeowners' Association.



Chapter Seven

CONSTRUCTION SITES STORMWATER POLLUTION PREVENTION STANDARDS

The requirements contained in this chapter are intended to prevent stormwater pollution resulting from soil erosion and sedimentation or from mishandling of solid and hazardous waste. Practices and measures included herein should assure that no foreign substance, (e.g., sediment, construction debris, chemicals) be transported from a site and allowed to enter any drainage way, whether intentionally or accidentally, by machinery, wind, rain, runoff, or other means.

A. POLLUTANTS OF CONCERN DURING CONSTRUCTION

The major pollutant of concern during construction is sediment. Natural erosion processes are accelerated at a project site by the construction process for a number of reasons, including the loss of surface vegetation and compaction damage to the soil structure itself, resulting in reduced infiltration and increased surface runoff. Clearing and grading operations also expose subsoils which are often poorly suited to re-establish vegetation, leading to longer-term erosion problems.

Problems associated with construction site erosion include transport of pollutants attached to transported sediment; increased turbidity (reduced light) in receiving waters; recreational use impairment. The deposited sediment may pose direct toxicity to wildlife, or smother existing spawning areas and habitat. This siltation also reduces the capacity of waterways, resulting in increased flood hazards to the public.

Other pollutants of concern during the construction process are hazardous wastes or hydrocarbons associated with the construction equipment or processes. Examples include concrete washout, paints, solvents, and hydrocarbons from refueling operations. Poor control and handling of toxic construction materials pose an acute (short-term) or chronic (long-term) risk of death to aquatic life, wildlife, and the general public.

B. EROSION AND SEDIMENT CONTROL REQUIREMENTS

General and Implementation Requirements - The following general and implementation requirements apply to all land-disturbing activities and shall be considered in the preparation of a SWPPP within the corporate boundaries of the Clark County.

1. Certified professionals must be utilized for activities associated with the development and design of the SWPPP, stormwater measure implementation, and stormwater project management.
2. Minimize the potential for soil erosion by designing a development that fits the topography and soils of the site. Unless needed to meet requirements and goals of the development, steep slopes should be avoided, and natural contours should be followed.
3. All activities on a site should be conducted in a logical sequence and in accordance with the site's construction phasing plan so that the smallest practical area of land will be exposed for the shortest practical period of time during development.

4. The length and steepness of designed slopes should be minimized to reduce erosion potential. Drainage channels and swales must be designed and adequately protected so that their final gradients and resultant velocities will not cause erosion in the receiving channel or at the outlet. Methods for determining acceptable velocities are included in this Stormwater Technical Standards Manual as well as in the IDEM Storm Water Quality Manual.
5. Sediment-laden water which otherwise would flow from the project site shall be managed by appropriate erosion and sediment control measures to minimize sedimentation to receiving waters and adjacent properties as discussed in the IDEM Storm Water Quality Manual and other authoritative sources.
6. Public roadways and roadways not exclusive to construction traffic shall be kept cleared of accumulated sediment that is a result of runoff or tracking. The following minimum conditions are applicable:
 - a. Clearing of sediment must not include the utilization of mechanical methods that will result in mobilization of dust off the project site or flushing the area with water unless the flushed water is directed to an appropriate sediment control measure.
 - b. Cleared sediment must be redistributed or disposed of in a manner that is in accordance with all applicable statutes and regulations.
 - c. Sediment discharged or tracked onto roadways that are open to traffic must be removed as directed by a regulatory authority or at a minimum, removed by the end of the same day.
7. Phasing of construction activities must be used, when feasible, to minimize the footprint of disturbed unstable areas.
8. Collected runoff leaving a project site must be either discharged directly into a well-defined, stable receiving channel, or diffused and released to adjacent property without causing an erosion or pollutant problem to the adjacent property owner.
9. Natural features, including wetlands and sinkholes (karst features), shall be protected from pollutants associated with stormwater runoff, through appropriate stormwater management and/or treatment measures.
10. Soil compaction is to be minimized, especially in areas where permanent vegetation will be re-established and/or areas that are designated to infiltrate stormwater for the post-construction phase.
11. Topsoil must be preserved, unless infeasible.
12. Existing natural buffers that are adjacent to waters of the state must be preserved to promote infiltration and provide protection of the water resource, unless infeasible. Activities performed by a county drainage board under IC 36-9-27 are excluded.
 - a. Natural buffers must be preserved, including the entire buffer bordering and/or surrounding the water resource. Existing buffers:
 - i. 50 feet or more in width must be preserved to a minimum of 50 feet.
 - ii. less than 50 feet in width must be preserved in their entirety. May be enhanced with vegetation that is native and promotes ecological improvement and sustainability.
 - b. Runoff directed to the natural buffer must be:
 - i. treated with appropriate erosion and sediment control measures prior to discharging to the buffer.

- ii. managed with appropriate runoff control measures to prevent erosion from occurring within the buffer area.
 - c. Further information regarding buffer requirements is contained in IDEM's "Implementation of Buffers" guidance document.
13. Minimize the generation of dust through dust suppression techniques to prevent deposition into waters of the state and areas located beyond the permitted boundaries of the site as discussed in the IDEM Storm Water Quality Manual and other authoritative sources.
14. A stable construction site access measure must be provided at all points of construction traffic ingress and egress to the project site. Where the selected measure is not effective, an alternative measure or additional controls must be utilized to minimize tracking. Alternative measures may include, but are not limited to, wheel wash systems and rumble strips.
15. During the period of construction activities, all stormwater management measures necessary to meet the requirements of this permit must be maintained. Alternative measures must be selected and implemented, as necessary.
16. Discharge water from dewatering of ground water from excavations, trenches, foundations, etc. must not be discharged when:
- a. Sediment-laden water is not first directed to an appropriate sediment control measure or a series of control measures, as per IDEM Storm Water Quality Manual and other authoritative sources, that minimizes the discharge of the sediment.
 - b. A visible sheen and/or pollutants are present at a level that requires additional treatment and/or an alternate permit.
17. Appropriate measures must be implemented to eliminate wastes or unused building materials including, but not limited to garbage, debris, cleaning wastes, wastewater, concrete washout, mortar/masonry products, soil stabilizers, lime stabilization materials, and other substances from being carried from a project site by runoff or wind. Wastes and unused building materials must be managed and disposed of in accordance with all applicable statutes and regulations.
18. Construction and domestic waste must be managed to prevent the discharge of pollutants and windblown debris. Surplus plastic or hardened concrete/cementitious materials are not required to be placed in trash receptacles and are considered clean fill that may be reused, disposed of on-site, or recycled in accordance with applicable state and federal regulations. Management of waste materials may include, but are not limited to:
- a. Waste containers (trash receptacles), when selected to manage waste, must be managed to reduce the discharge of pollutants and blowing of debris. Receptacles that are not appropriately managed will require alternatives that include but are not limited to:
 - i. A cover (e.g., lid, tarp, plastic sheeting, temporary roof) to minimize exposure of wastes to precipitation or
 - ii. A similarly effective method designed to minimize the discharge of pollutants.
 - b. Waste that is not disposed of in trash receptacles must be protected from exposure to the weather and/or removed at the end of the day from the site and disposed of properly.
19. Concrete washout areas, where concrete washout is permissible, must be identified for the site and the locations clearly posted. Wash water must be directed into leak-proof containers or leak-proof

containment areas which are located and designed to divert runoff away from the measure and sized to prevent the discharge and/or overflow of the concrete wash water. If not evaporated, wash water must be removed (pumped) for appropriate off-site disposal.

20. Fertilizer applications associated with the stabilization plan for the project must meet the following requirements:
 - a. Apply fertilizer at a rate and amount as determined by a soil analysis or in accordance with the Indiana Stormwater Quality Manual or similar guidance documents.
 - b. Apply fertilizer at an appropriate time of year for the project location, taking into consideration proximity to a waterbody, and preferably timed to coincide with the period of maximum vegetative uptake and growth.
 - c. Avoid applying fertilizer immediately prior to precipitation events that are anticipated to result in stormwater runoff from the application area.

21. Proper storage and handling of materials, such as fuels or hazardous wastes, and spill prevention and clean-up measures must be implemented to minimize the potential for pollutants to contaminate surface or ground water or degrade soil quality. To meet this requirement:
 - a. A spill prevention and response plan, meeting the requirements in 327 IAC 2-6.1, must be completed.
 - b. Proper project management and the utilization of appropriate measures including, but not limited to, eliminating a source or the exposure of materials must be completed.
 - c. Manage the following activities:
 - i. Fueling and maintenance of equipment.
 - ii. Washing of equipment and vehicles.
 - iii. Storage, handling, and disposal of construction materials, products, and wastes.
 - iv. Application of pesticides, herbicides, insecticides, and fertilizers
 - v. Dispensing and utilization of diesel fuel, oil, hydraulic fluids, other petroleum products, and other chemicals.
 - vi. Handling and disposal of hazardous wastes, including, but not limited to paints, solvents, petroleum-based products, wood preservatives, additives, curing compounds, and acids.
 - vii. Washing of applicators and containers used for paint, grout, or other materials.

22. Personnel associated with the project must be informed of the terms and conditions of this permit and the requirements within the SWPPP. The permittee is required to document this process. Information must be provided through written notification, contracts, or other means (i.e., pre-construction meetings) that effectively communicates the provisions and requirements of the permit and SWPPP. Personnel may include, but are not limited to:
 - a. General contractors, construction management firms, grading or excavating contractors, and trade industry representatives (i.e. concrete industry) associated with the overall project.
 - b. Contractors or individual lot operators that have primary oversight on individual building lots.
 - c. Those responsible for the implementation of the SWPPP, and the installation, repair, and maintenance of stormwater measures.
 - d. Those responsible for the application and storage of treatment chemicals.
 - e. Those responsible for administering the self-monitoring program (SMP).

23. A notice must be posted near the main entrance of the project site or at a publicly accessible location. For linear project sites, such as a pipeline or highway, the notice must be placed in a publicly accessible location near the project field office.

The notice must be maintained in a legible condition and include:

- a. A copy of the completed IDEM NOI or a document that at a minimum contains the information referenced in Section 6 (c)1 of the Clark County Stormwater Management Ordinance.
 - b. The NPDES permit number(s), upon receipt.
 - c. The location of the construction plan/SWPPP if the project site does not have an on-site location to store the plan.
24. The use of anionic polymers (cationic polymers are not authorized for use) on the project site are authorized for sediment control provided their use is in conformance with current State of Indiana standards and specifications and the use is identified in the stormwater pollution prevention plan (SWPPP). If use of a polymer is not in the SWPPP and is selected at a later date, notification to IDEM and the CCDB or designee is required. An email notification prior to the use of the polymer to the IDEM Stormwater Program is acceptable. For projects regulated by a MS4 notification must follow the local process for the use of polymers.
25. Restoration and/or clean-up may be required for those areas impacted by sediment or other pollutant discharges. These activities will be performed as directed by the inspecting authority and may require:
- a. Development and submittal of a removal and restoration plan to ensure the methodology chosen will not result in further degradation of the resource.
 - b. Permission by a property owner when the restoration activity requires access to a property owned by another entity or individual.
 - c. Additional permits prior to initiation of the work.

Stabilization Requirements - The following stabilization requirements apply to all land-disturbing activities:

- 1. Un-vegetated areas that are left idle or scheduled to be left inactive must be temporarily or permanently stabilized with measures appropriate for the season to minimize erosion potential. To meet this requirement, the following apply:
 - a. Stabilization must be initiated by the end of the seventh day the area is left idle. The stabilization activity must be completed within fourteen (14) days after initiation.. Initiation of stabilization includes, but is not limited to, the seeding and/or planting of the exposed area and applying mulch or other temporary surface stabilization methods where appropriate. Areas that are not accessible due to an unexpected and disruptive event that prevents construction activities are not considered idle.
 - b. Areas that have been compacted may be excluded from the stabilization requirement when the areas are intended to be impervious surfaces associated with the final land use, provided runoff from the area is directed to appropriate sediment control measures.
- 2. Final stabilization of a project site is achieved when:
 - a. All land-disturbing activities have been completed and a uniform (evenly distributed, without large bare areas) perennial vegetative cover with a density of seventy percent (70%) has been established on all unpaved disturbed areas, and areas not covered by permanent structures, or equivalent permanent stabilization measures have been employed. This requirement does not apply to:
 - i. Landscaping that is part of the final project plan is considered stable when the plan has been fully implemented and areas not being vegetated are stable with a non-erosive material and/or product.
 - ii. Projects or specific stormwater measures that utilize native vegetation and/or special vegetative plantings that are either required by a water quality permit/authorization or part of

the design and functionality of a stormwater measure provided the activity does not pose a threat that will result in off-site sedimentation.

- iii. Projects on land used for agricultural purposes when:
 - a) Stabilization is completed in accordance with the above Stabilization Requirements (in 1. a. and b.) as land-disturbance progresses. Land that is returned to agricultural production must be temporarily or permanently seeded upon completing land-disturbing activities. Stabilization requirements may be waived by the inspecting authority if the project site does not pose a threat of discharging sediment.
 - b) Disturbed areas, not previously used for agricultural production, such as filter strips, must be returned to their pre land disturbance use.
- b. Specific projects, due to function and/or operation may necessitate that an area remain disturbed. Only the minimum operational area is allowed to remain disturbed. This option primarily applies to off-road recreational commercial operations but may apply to other land use types upon determination by the regulating entity.

Design Requirements - The following design requirements apply to all land-disturbing activities and shall be considered in the selection, design, and implementation of all stormwater quality and management measures contained in the SWPPP:

1. Sound engineering, agronomic, and scientific principles must be utilized for measures contained in the SWPPP.
2. Appropriate measures must be planned, designed, and installed as part of an erosion and sediment control system and in accordance with the site's construction phasing plan.
3. Stormwater runoff leaving the project site must be discharged in a manner that is consistent with this ordinance, state, or federal law.
4. Collected runoff leaving the project site must be directed to an established vegetated area, when feasible and applicable, to increase pollutant removal and maximize stormwater infiltration and then either discharged directly into a well-defined, stable receiving conveyance or diffused and released without causing erosion at the point of discharge.
5. Conveyance systems must be designed taking into consideration both peak flow and total volume and must be adequately protected so that their final gradients and resultant velocities are unlikely to cause erosion at the outlet or in the receiving channel, based on known conditions of the discharge at the time of design to accommodate post-construction conditions.
6. Sediment basins, where feasible, must withdraw water from the surface of the water column unless equivalent sediment reduction can be achieved by use of alternative measures. Alternative measures include but are not limited to increasing the basin length to width ratio to 4:1 or greater, implementation of porous baffles, use of flocculants/polymers, and/or phasing of project land disturbance that also incorporates a rapid stabilization program. During freezing conditions, the implementation of alternative withdrawal methods may be utilized.

Monitoring and Management Requirements - A trained individual, acceptable to the CCDB or designee shall monitor project construction and stormwater activities. These shall include:

1. A written evaluation of the entire project site, with the exception of those areas that are considered unsafe. The evaluation must be performed by a trained individual and completed:

- a. Twenty-four (24) hours prior to a qualifying precipitation event or by the end of the next business day following each measurable storm event (excludes accumulated snow events); which is defined as a precipitation accumulation equal to, or greater than, one-half (0.50) inch of rainfall within a 24-hour period. If no rain event occurs within the work week a minimum of one inspection must occur. In the event of multiple qualifying events during the work week, no more than three (3) inspections would be required to meet the self-monitoring commitment.
 - b. At a minimum of one (1) time per month for specific areas within the project which are stabilized with permanent vegetative cover at seventy (70) percent density and/or erosion resistant armoring is installed. A reduction to once per month is also applicable for the entire project site for stabilized common areas, basins, conveyances, outfalls, and inactive building sites. Prior to reducing the monitoring to monthly, records must identify the area and the date the area became eligible for monthly monitoring. Weekly monitoring as identified in (a) above must resume if one or more of the following occurs:
 - i. The vegetative cover fails or there is evidence of erosion in the identified area.
 - ii. The CCDB or designee requires monitoring to resume.
2. A complete written evaluation report which must include:
- a. Name of the individual performing the evaluation, including printed name, title, and signature (electronic signatures are acceptable).
 - b. Date of the evaluation.
 - c. Amount of precipitation, when the evaluation is conducted after a measurable storm event. Recorded rainfall may be documented utilizing an on-site rain gauge or storm event information from a weather station that is representative of the project location.
 - d. Observations of project performance in relation to:
 - i. Implementation of the stormwater pollution prevention plan.
 - ii. Assessment of existing stormwater measures based on industry standards and maintenance standards as identified in Section 5 of the Stormwater Permit Application Form (found in Appendix B1 of this document) to ensure each measure is operational and functioning properly.
 - iii. Additional measures necessary in the event an existing measure fails or is not present in the landscape
 - iv. Impacts including, but not limited to, sediment discharges, erosion, discharges that results in bank erosion, and operational activities that have the potential to generate pollutants and unauthorized discharges.
 - e. Documentation of an actual discharge that is visible during the assessment, the location of the discharge and a visual description of the discharge. The visual description includes, but is not limited to, color (turbidity reading is an option), odor, floatables, settled/suspended solids, foam, oil sheen, and any other visible sign that may be attributed to operations occurring on the project site.
 - f. Detail of corrective action recommended and/or completed. Corrective action includes, but is not limited to:
 - i. Repairing, modifying, or replacing any stormwater management measure.
 - ii. Clean-up and proper disposal of spills, releases, or other deposits.
 - iii. Remedying a permit violation.
 - iv. Taking reasonable steps to remediate, minimize or prevent the discharge of pollutants associated with the construction activity until a permanent corrective solution is initiated.
 - v. Restoring an impacted area and/or removing accumulated sediment, provided appropriate permission and permits are obtained to conduct the activity.

- g. A timeline for which the corrective action will occur to remediate the discharge of pollutants. The established corrective action, at a minimum, must be initiated:
 - i. On the day the deficiency was discovered or when it is not practical to initiate on the discovery date, no later than forty- eight (48) hours for the repair of a measure or installation of a temporary measure until a new and/or replacement measure is installed as specified in item ii) below.
 - ii. Within seven (7) days of discovery for the installation of a new (alternative) measure or replacement of an existing measure unless a shorter timeframe is required as part of a regulatory inspection. The inspecting authority may also allow additional time to take corrective action.
 - iii. If corrective action cannot be achieved within the timelines outlined in i) or ii) above, a reason for incompleteness must be provided and documented, including the anticipated completion date.
 - h. Documentation of corrective action taken from the previous self-monitoring report.
- 3. Maintaining the SMP reports at the site or at an easily accessible location (refer to Project Documentation Requirements below).
 - 4. Providing all reports for the project site to CCDB or designee within forty-eight (48) hours of a request. Electronic copies are acceptable, provided they are in a format consistent with the paper record.

Project Documentation Requirements – The following project documentation shall be developed and maintained:

- 1. Maintain a project management log that contains:
 - a. Information related to all off-site borrow sites, disposal areas, and staging areas, including the location of each activity as it is identified and/or selected.
 - b. Information related to all project activities including, but not limited to:
 - i. SMP reports.
 - ii. Regulatory inspections.
 - iii. Responses to a compliance action or enforcement action.
 - iv. Records showing the dates of all SWPPP modifications. The records must include the name of the person authorizing each change and a summary of all changes.
- 2. Ensure the SWPPP and supporting documentation associated with the SMP and project management log are accessible at the project site office or in the possession of on-site individuals with responsibility for the overall project management or associated with the management and operations of construction activities. This information must be provided to CCDB or designee within forty-eight (48) hours of a request.

C. COMMON CONTROL PRACTICES

All erosion control and stormwater pollution prevention measures required to comply with the Ordinance or these Technical Standards shall meet the design criteria, standards, and specifications similar to or the same as those outlined in the "Indiana Storm Water Quality Manual" (ISWQM), or other comparable and reputable references. Please note that pursuant to IC 13-18-27, MS4-designated entities may not require erosion and sediment control measures/BMPs that are more stringent than the measures/BMPs required by the IDEM general permit.

D. INDIVIDUAL LOT OR PARCEL CONTROLS

Although individual lots within a larger development may not appear to contribute as much sediment as the overall development, the cumulative effect of lot development is of concern. The same is true for individual parcels of land of any size that are not associated with a larger development. From the time construction on an individual lot begins, until the individual lot is stabilized, the builder must take steps to:

- protect adjacent properties from sedimentation
- prevent mud/sediment from depositing on the street
- protect drainageways from erosion and sedimentation
- prevent sediment laden water from entering storm sewer inlets.

This can be accomplished using numerous erosion and sediment control measures. Individual lot permit request form, plot plan review form and detailed requirements, including a standard erosion control plan for individual lots, are provided in Appendix B. The standard plan includes perimeter silt fence, stabilized construction entrance, drop inlet protection, stockpile containment, stabilized drainage swales, downspout extensions, temporary seeding and mulching, and permanent vegetation. Every relevant measure should be installed at each individual lot site. Note that construction site discharge must be contained and treated within each individual lot (or a group of individual lots being constructed by one builder) and is not allowed to be discharged offsite.

Construction sequence on individual lots and parcels should be as follows:

1. Clearly delineate areas of trees, shrubs, and vegetation that are to be undisturbed. To prevent root damage, the areas delineated for tree protection should be at least the same diameter as the crown.
2. Install perimeter silt fence at construction limits. Position the fence to intercept runoff prior to entering drainage swales.
3. Avoid disturbing drainage swales if vegetation is established. If drainage swales are bare, install erosion control blankets or sod to immediately stabilize.
4. Install drop inlet protection for all inlets on the property.
5. Install stable construction entrance that extends from the street to the building pad.
6. Perform primary grading operations.
7. Contain erosion from any soil stockpiles created on-site with an appropriate sediment control measure around the base.
8. Establish temporary seeding and straw mulch on disturbed areas.
9. Construct the home and install utilities.
10. Install downspout extenders once the roof and gutters have been constructed. Extenders should outlet to a stabilized area.
11. Re-seed any areas disturbed by construction and utilities installation with temporary seed mix within 3 days of completion of disturbance.
12. Grade the site to final elevations.

13. Install permanent seeding or sod.

All erosion and sediment control measures must be properly maintained throughout construction. Temporary and permanent seeding should be watered as needed until established. For further information on individual lot and parcel erosion and sediment control, please see the "Individual Lot Erosion and Sediment Control Plan and Certification" form and other resources in Appendix B as well as the latest information posted on IDEM's website.



Chapter Eight

POST-CONSTRUCTION STORMWATER QUALITY MANAGEMENT STANDARDS

A. INTRODUCTION

It is recognized that developed areas, as compared to undeveloped areas, generally have increased imperviousness, decreased infiltration rates, increased runoff rates, and increased concentrations of pollutants such as fertilizers, herbicides, greases, oil, salts and other pollutants. As new development and re-development continues within areas subject to Clark County jurisdiction, measures must be taken to intercept and filter pollutants from stormwater runoff prior to reaching regional creeks, streams, and rivers. Through the use of appropriate Best Management Practices (BMPs), stormwater runoff will be filtered and harmful amounts of sediment, nutrients, and contaminants will be removed.

It is also recognized that another major source of pollution in many Indiana streams, including those within Clark County, is the streambank erosion associated with urbanizing watersheds. Stream channels develop their shape in response to the volume and rate of runoff that they receive from their contributing watersheds. Research has shown that in hydrologically stable watersheds, the stream flow responsible for most of the shaping of the channel (called the bankfull flow) occurs between every one to two years. When land is developed, the volume and rate of runoff from that land increases for these comparatively small flooding events that are not normally addressed by the detention practices and the stream channel will adapt by changing its shape. As the stream channel works to reach a new stable shape, excess erosion occurs. As new development and re-development continues within Clark County, measures must be taken to minimize the impact of such development or re-development on streambank erosion. Through the use of appropriate Best Management Practices (BMPs), the volume and rate of runoff for channel-forming flows will be reduced in an attempt to minimize increased streambank erosion in the receiving streams and channels.

Requirements of the Ordinance and this Technical Standards Manual with regards to the channel protection and water quality protection can be satisfied through a variety of methods that can be broadly categorized under two general approaches:

1. Conventional Approach
2. Low Impact Development (LID) Approach

This Chapter establishes minimum standards for the selection and design of post-construction water quality and channel protection BMPs. The information provided in this Chapter establishes performance criteria for stormwater quality management and procedures to be followed when preparing a BMP plan for compliance. Post-construction BMPs must be sized to treat the channel protection volume (CPv), water quality volume (WQv), and for flow-through BMPs the water quality discharge rate (Qwq), as appropriate. For Conventional approach, the methodology for calculating the CPv, WQv, and Qwq values is provided in Chapter 9. For LID approach, alternative methods of calculating these values are provided in Section F of this Chapter.

B. POST-CONSTRUCTION BMPs PERFORMANCE CRITERIA

Channel protection is typically achieved by matching the post-construction runoff volume and rate to the pre-conversion (prior to any historical land conversion by man) condition for all runoff events up to the bankfull flow. The bankfull flow in most Indiana streams correlates with the 1.5- to 2-year flood event flow. However, due to difficulties in determining the pre-conversion conditions, the net control of runoff resulting from a 1-year, 24-hour storm in proposed conditions (rather than the alternative method of determining increase in 2-year, 24-hour storm over pre-conversion conditions) is established as the Clark County standard for channel protection.

CCDB has also established a minimum standard that the measurement of the effectiveness of the control of post-construction stormwater runoff quality will be based on removal of floatables in stormwater runoff and treatment, to the maximum extent practicable, of all major pollutants of concern expected for the proposed land use and/or those identified in the Storm Water Pollution Prevention Plan (SWPPP) for the site (including, if applicable, those pollutants found to be the cause of the receiving stream to be listed in IDEM 303(d) list) for the first inch of rainfall at the site. The above-noted "maximum extent practicable" criterion is subject to a minimum of 80% removal of Total Suspended Solids (TSS). These requirements are adopted as the basis of the Clark County stormwater quality management program for all areas of the jurisdiction.

For the purpose of these Standards, the control of channel protection volume and post-construction stormwater runoff quality is assumed satisfactory when the appropriate number of pre-approved structural BMPs, tiered in accordance to the total site disturbed area as shown below, are designed, installed, and operated in accordance with fact sheets provided in the appendices provided in the Indiana Office of Community and Rural Affairs (OCRA) Green Infrastructure Curriculum and Training web resources (<https://www.in.gov/ocra/2367.htm>).

Total Property/Development Area	Post-Construction BMP Requirement*
0 to less than 1 acre	Water Quality BMP Not Required
At least 1 acre	At least 1 Water Quality BMP
At least 10 acres	Channel Protection Volume **

* These BMPs are in addition to any pre-treatment that may be required for hot spots.

** When the CPv is controlled with BMPs that also meet the stormwater quality performance criteria in Section B, often no additional water quality BMP is necessary. An additional water quality BMP may be required if the CPv is not believed to adequately address water quality requirements.

C. POLLUTANTS OF CONCERN AFTER CONSTRUCTION STABILIZATION

There are three major sources of pollutants for a stabilized construction site:

- Deposition of atmospheric material (including wind-eroded material and dust)
- General urban pollution (thermal pollution, litter)
- Pollutants associated with specific land uses

It should be noted that some pollutants accumulate on impervious surfaces. This accumulated material is then subject to being washed into watercourses during storm events. It is for this reason that fish kills often occur during a rain event with a substantial prior rainless period. This is also the reason that the

most hazardous driving conditions are realized after the initial onset of a storm event, when deposited oil has not yet washed into adjacent conveyance systems.

Pollutants of concern include:

- **Sediment** is the major pollutant of concern during active construction. Natural erosion processes are accelerated at a project site by the construction process for a number of reasons, including the loss of surface vegetation and compaction damage to the soil structure itself, resulting in reduced infiltration and increased surface runoff. After the construction is completed, other chemicals that are released to surface waters from industrial and municipal discharges and polluted runoff from urban and agricultural areas continue to accumulate to harmful levels in sediments.
- **Toxic chemicals** from illegal dumping and poor storage and handling of materials. Industrial sites pose the most highly variable source of this pollution due to the dependency of the specific process to the resulting pollution amounts and constituents. As during construction, these chemicals can pose acute (short-term) or chronic (long-term) risk to aquatic life, wildlife and the general public.
- **Bacteria** from illicit sanitary connections to storm sewer systems, combined sewers, leaking septic systems, wildlife and domestic animal waste. Bacteria pathogens pose a direct health risk to humans and aquatic life.
- **Nutrients** can be released from leaking septic systems or applied in the form of fertilizers. Golf courses, manicured landscapes and agricultural sources are the primary land uses associated with excess fertilization. Excessive nutrients in the local ecosystem are the source of algal blooms in ponds and lakes. These excessive nutrients also lead to acceleration of the eutrophication process, reducing the usable lifespan of these water bodies. Nitrogen and phosphorous are the primary nutrients of concern.
- **Oxygen demand** can be impacted by chemicals transported on sediment, by nutrients, and other pollutants (such as toxic chemicals). Reduced levels of oxygen impair or destroy aquatic life.
- **Oils and hydrocarbons** accumulate in streets from vehicles. They can also be associated with fueling stations and illicit dumping activities. Oils and hydrocarbons pose health risk to both aquatic and human health.
- **Litter, including floatables**, can result in a threat to aquatic life. The aesthetic impact can also reduce the quality of recreational use.
- **Metals** can be associated with vehicular activity (including certain brake dusts), buildings, construction material storage, and industrial activities. Metals are often toxic to aquatic life and threaten human health.
- **Chlorides (salts)** are historically associated with deicing activities. Chlorides are toxic to native aquatic life (verses saltwater aquatic life). Communities should consider a combination of cinders or sand to replace or supplement their deicing activities with chlorides. In addition, chloride stockpiles should remain covered.
- **Thermal effects** can be introduced by the removal of shade provided by riparian trees, as well as impervious channel linings, such as concrete, which release stored heat to water passing over them. Other sources of elevated temperature include effluent from power plant and industrial activities. Thermal pollution can threaten aquatic habitat, including fish species and beneficial water insects. Of particular concern are salmonid streams, due to the effect of thermal pollution on spawning for this particular species.

D. WATER QUALITY CHARACTERISTICS BY LAND USE

Direct water quality sampling is not generally required at this time by IDEM. However, water quality characteristics are strongly tied to land use. For the purpose of these standards, all proposed developments and re-developments shall be assumed to involve increased levels of floatables, TSS, TP, TN, and metals. Additional pollutants may also be expected at certain types of developments and specific

sites, as identified in the Storm Water Pollution Prevention Plan for the site (including, if applicable, those pollutants found to be the cause of the receiving stream to be listed in IDEM 303(d) list).

E. CONVENTIONAL APPROACH PROCEDURES

The following procedures shall be followed according to the Conventional approach:

Step 1: Provide BMPs to address Channel Protection Volume

In a conventional approach, the receiving channel is protected through retaining (when possible) or the extended detention (if infiltration methods are considered ineffective/ inappropriate for the site) of the 1-year, 24-hour storm event on entire site (excluding any protected undisturbed areas acceptable to the CCDB or designee) tributary to each outlet. The methodology for calculating the Channel Protection Volume (CPv) is according to that discussed in Chapter 9 of this Standards Manual. Both retention or wet/dry extended detention may be used so long as only 10% of the maximum stored volume is left in the basin after 36 hours from maximum storage time (or 48 hours from the start of storm) and no more than 40% of the maximum stored volume is released within the first 12 hours. To ensure that adequate retention/detention volume is available within the facility over the years, the facility should be designed for long-term sediment accumulation. If long-term sediment accumulation cannot be adequately provided for in the pond, or if the pond is intended to provide sediment control during the construction phase of the project, forebays near inlets can be included to help manage sediment accumulation. Forebays do not require a hard maintenance surface and shall not be visibly disconnected from the pond by rip rap or other berm structures.

Since, by design, 90% of the original volume will be available within 48 hours of start of each storm event (assumed to be about 36 hours from when the Channel Protection pool is full), the volume in the pond associated with the channel protection (CPv) may be assumed empty for the purpose of peak flow retention/detention analysis discussed in Chapter 6. In addition, the volume provided for channel protection would also count as one BMP towards the water quality requirements, provided that the facility meets the design criteria in the fact sheet and additional pre-treatment and/or wetland fringe can be provided to assure the performance criteria noted in Section B of this Chapter are met.

Step 2: Provide BMPs to address Water Quality Management

When the channel protection volume is controlled with BMPs that also meet the stormwater quality performance criteria in Section B (including both the required type and also the number of BMP in series), often no additional calculation or BMP implementation is necessary. If the channel protection volume is not controlled through practices that also meet the stormwater quality performance criteria in Section B, additional BMPs will be required. CCDB has designated a number of pre-approved structural BMP methods (listed in Table 8-1 for Conventional Approach and Tables 8-4 through 8-6 for LID Approach) to be used alone or in combination to achieve the stormwater quality performance criteria noted in Section B of this Chapter for runoff generated from up to first inch of rainfall on the entire site (excluding any protected undisturbed areas acceptable to the CCDB or designee) tributary to each outlet. Details regarding the applicability and design of these pre-approved BMPs, including the effectiveness of these BMPs in treating pollutants of concern (including, if applicable, those pollutants found to be the cause of the receiving stream to be listed in the IDEM 303(d) list), are contained within fact sheets presented in the appendices provided in the Indiana Office of Community and Rural Affairs (OCRA) Green Infrastructure Curriculum and Training web resources (<https://www.in.gov/ocra/2367.htm>). Additional information on recommended plant lists and recommended materials used for construction of stormwater BMPs are also provided in those appendices.

Innovative BMPs, including but not limited to, BMPs not previously accepted by CCDB or designee must be certified by a Professional Engineer licensed in State of Indiana and approved through CCDB or designee. ASTM standard methods must be followed when verifying performance of new measures. New BMPs, individually or in combination, must meet the performance criteria noted in Section B of this Chapter, including the capture and removal of floatables. All innovative BMPs must have a low to medium

maintenance requirement to be considered by CCDB or designee. Testing to establish the pollutant removal rate must be conducted by an independent testing facility, not the BMP manufacturer. The accepted design flow rate for a Water Quality Device shall be the flow value at which the claimed removal rate for TSS is equaled or exceeded based on the unit's efficiency curve (flow rate versus removal rate graph).

Note that a single BMP measure may not be adequate to achieve the water quality requirements (as noted above) for a project. It is for this reason that a "treatment train", a number of BMPs in series, is often required for a project. The pollutant removal efficiency of a number of BMPs in series may be determined from the following formula:

$$E_{\text{series}} = 1 - (1 - E_1)(1 - E_2)(1 - E_3) \dots$$

where,

E_{series} = Removal Efficiency of the BMP series combined (in decimal form)

E_1, E_2, E_3, \dots = Removal Efficiency of Units 1, 2, 3, ..., respectively (in decimal form)

**TABLE 8-1
Pre-approved Post-Construction BMPs for Conventional Approach**

BMP ^A	Typical % Removal Efficiency ^B	Maintenance Easement Requirements
	TSS	
Bioretention	90 ^C	25 feet wide along the perimeter
Constructed Wetland	67 ^C	25 feet wide along the outer perimeter of forebay & 30 feet wide along centerline of outlet
Underground Detention	70	20 feet wide strip from access easement to tank's access shaft & 30 feet wide along centerline of inlet and outlet
Extended Detention/Dry Pond	72	25 feet wide along the outer perimeter of forebay & 30 feet wide along centerline of outlet
Infiltration Basin (including retention ponds with pretreatment)	90 ^C	25 feet wide along the perimeter
Infiltration Trench	90 ^C	25 feet wide along the perimeter
Constructed (Sand) Filter	70 ^C	25 feet wide along the perimeter
Water Quality Device	VARIES ^D	20 feet wide strip from access easement to chamber's access shaft
Vegetated Filter Strip	78 ^C	25 feet wide along the length on the pavement side
Vegetated Swale	81 ^C	25 feet wide along the top of bank on one side
Wet Ponds/Retention Basin	80	25 feet wide along the outer perimeter of forebay & 30 feet wide along centerline of outlet

Notes:

- A. Detailed specifications for these BMPs are provided in the fact sheets contained in the appendices provided in the Indiana Office of Community and Rural Affairs (OCRA) Green Infrastructure Curriculum and Training web resources (<https://www.in.gov/ocra/2367.htm>).
- B. Removal rates shown are based on typical results. Unless otherwise shown, data extracted from various data sources. These rates are also dependent on proper installation and maintenance. The ultimate responsibility for determining whether additional measures must be taken to meet the Ordinance requirements for site-specific conditions rests with the applicant.
- C. IDEM Stormwater Quality Manual, 2007.
- D. The removal rate for this category varies widely between various models and manufacturers. The acceptable treatment rate for these devices shall be based on that currently certified by the New Jersey Department of Environmental Protection (NJDEP). Further details on acceptable Water Quality Devices and their treatment rates are provided in Chapter 9.

F. LOW IMPACT DEVELOPMENT (LID) APPROACH PROCEDURES

Low Impact Development (LID) stormwater management design approaches are fundamentally different from conventional design approaches and challenge traditional thinking regarding development standards, watershed protection, and public participation. LID combines fundamental hydrologic concepts with many of today's common stormwater strategies, practices and techniques to reshape development patterns in a way that maintains natural watershed hydrologic functions. When a county or community has a stormwater user fee system based on imperviousness, the utilization of LID approach will often result in reduced stormwater user fee for non-residential lots, because LID reduces overall imperviousness of the lot. The five principles of LID are:

1. Conservation of existing natural and topographic features;
2. Minimization of land clearing and impervious surfaces;
3. Maintain or lengthen the pre-developed time of concentration;
4. Installation of integrated structural best management practices; and
5. Use of pollution prevention measures and practices.

Several methods for achieving the above principals are outlined below. In addition to methods described in this Standards Manual, several readily available references provide details on incorporating LID practices into site development. One of the most recent, comprehensive resources for incorporating LID practices into site development design is "Low Impact Development Manual for Michigan: A Design Guide for Implementers and Reviewers" available online at www.semcoq.org/LowImpactDevelopment.aspx. The noted resource was used extensively for the development of LID section in this Standards Manual.

The following steps shall be followed for the LID approach:

Step 1: Minimize Disturbed Areas and Protect Sensitive Areas

- Map sensitive areas such as waterbodies, floodplains, and natural flow paths. Identify hydrologic soil types on the maps. Show elevations and identify critical slopes of 15 percent to 25 percent and above 25 percent. Show areas of known contamination. Also show existing structures and infrastructure.
- Determine the total area of impervious surface existing prior to development.
- Note the seasonal high groundwater level.
- Designate sensitive areas that are proposed to be protected as part of the proposed layout.
- Lay out the proposed development, minimizing disturbance and avoiding the sensitive areas, utilizing existing soils.
- Utilize the non-structural BMPs listed in **Table 8-2** to properly protect sensitive areas so they maintain their pre-development state and runoff characteristics. Fact Sheets for these BMPs are provided in the appendices provided in the Indiana Office of Community and Rural Affairs (OCRA) Green Infrastructure Curriculum and Training web resources (<https://www.in.gov/ocra/2367.htm>).

**Table 8-2
Pre-approved BMPs with Treatment Area Reduction Recognitions for LID Approach**

BMP ^A	Runoff Reduction Recognition ^B
Protect Sensitive Areas	Area (acres complying with the requirements of this BMP) can be subtracted from site development area for Channel Protection Volume and Water Quality Volume/Rate calculations.
Protect Riparian Buffers	Area (acres complying with the requirements of this BMP) can be subtracted from site development area for Channel Protection Volume and Water Quality Volume/Rate calculations.
Minimize Total Disturbed Area	Area (acres complying with the requirements of this BMP) can be subtracted from site development area for Channel Protection Volume and Water Quality Volume/Rate calculations.
Reduce Impervious Surfaces	Area (acres complying with the requirements of this BMP) can be subtracted from site development area for Channel Protection Volume and Water Quality Volume/Rate calculations.
Protect Natural Flow Pathways	Area (acres complying with the requirements of this BMP) can be subtracted from site development area for Channel Protection Volume and Water Quality Volume/Rate calculations.
Cluster-Type Development	Area (undisturbed acres complying with the requirements of this BMP) can be subtracted from site development area for Channel Protection Volume and Water Quality Volume/Rate calculations.

Notes:

- A. In using and crediting these BMPs, applicants must meet the review criteria located within the discussion of each BMP provided in the appendices provided in the Indiana Office of Community and Rural Affairs (OCRA) Green Infrastructure Curriculum and Training web resources (<https://www.in.gov/ocra/2367.htm>).
- B. If the LID track is pursued, reduced CNs (associated with pre-developed underlying soil types instead of the normal requirement of assigning the post-development CN according to the next lower infiltration soil group) for areas protected by these BMPs may be used for determining the post-developed runoff rates and volumes for larger events (up to and including the 100-year event). See **Table 8-8**.

- As shown in Table 8-2, when using the LID Approach (and certain other circumstances determined as appropriate by the CCDB or designee), any area that is set aside and protected as described in those BMPs may be subtracted from site development area for purposes of determining Channel Protection Volume calculations and water quality volume/rate calculations.
- Since the LID track is being used, for determining the 10-year and 100-year runoff and peak discharges, the CN associated with the original, pre-development soil groups (instead of the normal requirement of assigning the post-development CN according to the next lower infiltration soil group) may be used for these areas (see **Table 8-8**).
- The runoff reduction recognition only works with designs based on the Curve Number or CN method of analysis utilizing non-composite CN determination methods.

Step 2: Restore Disturbed Areas

- For the LID Approach, runoff reduction recognitions are used in the design process to emphasize the use of BMPs that, when applied, restore/alter the disturbed area in a way that reduces the volume of runoff from that area.
- Runoff reduction recognition is provided for the five BMPs listed in **Table 8-3** because they enhance the response of a piece of land to a storm event rather than treat the runoff that is generated. These BMPs are encouraged because they are relatively easy to implement over structural controls, require little if any maintenance, and the land they are applied to remains open to other uses.
- Runoff reduction recognition is applied by reducing the default CN value so that the amount of runoff generated from an event is reduced.
- The runoff reduction recognition only works with designs based on the CN method of analysis utilizing non-composite CN determination methods.
- Fact sheets for these BMPs are provided in the appendices provided in the Indiana Office of Community and Rural Affairs (OCRA) Green Infrastructure Curriculum and Training web resources (<https://www.in.gov/ocra/2367.htm>).

**Table 8-3
Pre-approved BMPs with Runoff Reduction Recognitions for Restoring Disturbed Areas as Part of LID Approach**

BMP ^A	Runoff Reduction Recognition ^B
Minimize Soil Compaction	Area (acres complying with the requirements of this BMP) can be assigned a CN based on the pre-developed soil group conditions instead of the normal requirement of assigning the post-development CN according to the next lower infiltration soil group.
Protection of Existing Trees within disturbed areas (part of Protect Sensitive Areas)	Trees protected under the requirements of this BMP can be assigned a CN based on the pre-developed soil group conditions at a rate of 800 square feet per tree instead of the normal requirement of assigning Post-developed CN according to the next lower infiltration soil group for the acres covered by the tree area.
Soil Amendment and Restoration	Area (acres complying with the requirements of this BMP) can be assigned a CN based on the pre-developed soil group conditions instead of the normal requirement of assigning the post-development CN according to the next lower infiltration soil group.
Native Revegetation	Proposed trees and shrubs to be planted under the requirements of this BMP can be assigned a CN based on the pre-developed soil group conditions at a rate of 200 square feet per tree and 25 square feet per shrub instead of the normal requirement of assigning Post-developed CN according to the next lower infiltration soil group for the acres covered by the existing land use area.
Riparian Buffer Restoration	Proposed trees and shrubs to be planted under the requirements of this BMP can be assigned a CN based on the pre-developed soil group conditions at a rate of 200 square feet per tree and 25 square feet per shrub instead of the normal requirement of assigning Post-developed CN according to the next lower infiltration soil group for the acres covered by the existing land use area.

Notes:

- A. In using and crediting these BMPs, applicants must meet the review criteria located within the discussion of each BMP provided in the appendices provided in the Indiana Office of Community and Rural Affairs (OCRA) Green Infrastructure Curriculum and Training web resources (<https://www.in.gov/ocra/2367.htm>).
- B. If the LID track is pursued, reduced CNs (associated with pre-developed underlying soil types instead of the normal requirement of assigning the post-development CN according to the next lower infiltration soil group) for areas covered by these BMPs may be used for determining the post-developed runoff rates and volumes for larger events (up to and including the 100-year event). See **Table 8-8**.

Step 3: Minimize Imperviousness

- The BMPs listed in **Table 8-4** are designed to reduce the volume of runoff from hard surfaces such as roads, sidewalks, parking areas, roofs, etc. Runoff reduction recognition is used to encourage these practices and recognize their runoff reduction impacts when LID Approach is being pursued. Fact Sheets for these BMPs are provided in the appendices provided in the Indiana Office of Community and Rural Affairs (OCRA) Green Infrastructure Curriculum and Training web resources (<https://www.in.gov/ocra/2367.htm>).

**Table 8-4
Pre-approved BMPs with Runoff Reduction Credits for Reducing Imperviousness as Part of LID Approach**

BMP ^A	Runoff Reduction Recognition ^B
Porous Pavement	<p>Area covered by Porous Pavement with a minimum of 8 inch washed aggregate base may be assigned a weighted CN value of 87 (instead of CN of 98 normally used for impervious surfaces) for the purpose of Channel Protection Volume calculations. Use a weighted CN of 74 for the purpose of Water Quality Volume calculations, if needed.</p> <p>Note: If this BMP is specifically designed to provide permanent volume reduction through infiltration or through providing detention storage within the aggregate void, the volume reduction recognition discussed in Step 5 should be pursued instead of the CN reduction recognition, assuming CN of 98.</p>
Vegetated Roof	<p>Vegetated roofs are designed to reduce runoff volumes. However, the volume reduction is highly dependent on the media and planting used, with the calculation methods very complex at times. In lieu of calculating the volume reduction benefits, the roof area with vegetated roof with a minimum media depth of 4 inches and a void ratio of 0.3 (as described in the fact sheet) may be assigned a weighted CN of 87 (instead of CN of 98 normally used for impervious surfaces) for the purpose of Channel Protection Volume calculations. Use a weighted CN of 74 for the purpose of Water Quality Volume calculations, if needed.</p>

Notes:

- In using and crediting these BMPs, applicants must meet the review criteria located within the discussion of each BMP provided in the appendices provided in the Indiana Office of Community and Rural Affairs (OCRA) Green Infrastructure Curriculum and Training web resources (<https://www.in.gov/ocra/2367.htm>).
- If the LID track is pursued, reduced CNs for areas covered by these BMPs may be used for determining the post-developed runoff rates and volumes for larger events (up to and including the 100-year event). See **Table 8-8** for weighted CN values used for such larger events.

- Although imperviousness reduction BMPs are encouraged throughout any new development or re-development, the runoff reduction recognition may only be considered where the following conditions are met:
 - The BMP must be in the common areas and covered by an easement or other agreement that assigns responsibility for its maintenance.
 - The BMP must be covered by a maintenance plan and agreement with assurances for the long-term availability of maintenance funds (such as funds held in a permanent escrow account) in a form acceptable to CCDB or designee.

Step 4: Calculate the amount of volume control needed for channel protection

- Determine the 1-year 24-hour rainfall from Table 2-5,
- Delineate subbasins in a manner that, at a minimum and to the extent possible, the pervious and impervious surfaces are in different subbasins
- Determine the disturbed drainage area for each subbasin by subtracting the protected area determined in Step 1 from total contributing drainage area.
- Assign CN to each cover type and land use, assigning “credited CN” for areas treated in Steps 2 and 3 instead of normal post-development CN that is determined based on the proposed land use and the next less infiltrating underlying soil group, when applicable. Published pre-determined weighted CN values shall not be utilized for LID Approach. This applies regardless of whether manual methods or computer modeling techniques are used.
- Determine the total post-development 1-year, 24-hour runoff volume for the entire site’s disturbed areas through the use of acceptable computer models or manually as specified below. This is the net Channel Protection volume needing to be permanently removed by appropriate structural BMPs.
 - Computer Model: Use acceptable computer models (listed in Chapter 2) to determine the total runoff volume for the site, utilizing 1-year, 24 hour rainfall depth with Soil Conservation Service (SCS) type 2 storm distribution, drainage area, and CN determined above, according to the Soil Conservation Service (SCS) CN loss method along with SCS unitless hydrograph methodology.
 - Manual Calculation: If calculating manually, use the following formula:
 - **Runoff Volume (ft³) for each cover type = Qv x 1/12 x A**
 Where
 A = disturbed area of the particular cover type (ft²)
 Qv = Runoff Depth (in) = $(P - 0.2S)^2 / (P + 0.8S)$
 P = 1-Year, 24 Hr Rainfall (in)
 S = $(1000/CN) - 10$
 - Sum the individual volumes to obtain the total post-development runoff volume for area to be managed.

Step 5: Provide Distributed Volume Reduction/Infiltration Practices

- **Table 8-5** includes a list of the structural BMPs from potential BMPs that provide volume removal/retention. Select and design structural BMPs that provide volume control to meet, when combined, the total net channel protection volume determined in Step 4. Fact Sheets for these and other relevant post-construction structural BMPs are provided in the appendices provided in the Indiana Office of Community and Rural Affairs (OCRA) Green Infrastructure Curriculum and Training web resources (<https://www.in.gov/ocra/2367.htm>).

**Table 8-5
Pre-approved Structural BMPs with Permanent Volume Reduction Recognitions for Channel
Protection as Part of LID Approach**

BMP ^A	Channel Protection Volume Runoff Reduction Recognition ^B
Infiltration Practices (Infiltration Basin, Subsurface Infiltration Bed, Infiltration Trench, and Dry Well)	Volume reduction is achieved by surface storage volume (if included in the design), subsurface volume (if included in the design), and infiltration volume as described in the fact sheet. If an underdrain has to be used due to soil conditions, no recognition is granted for the "infiltration volume" portion.
Bioretention	Volume reduction is achieved by surface storage volume, soil storage volume, and infiltration bed volume as described in the fact sheet.
Vegetated Swale	Volume reduction is achieved by surface storage volume (if included in the design through inclusion of check dams) and active infiltration volume during the storm (when infiltration is expressly designed for as a purpose) as described in the fact sheet.

Notes:

A. In using and crediting these BMPs, applicants must meet the review criteria located within the discussion of each BMP provided in the appendices provided in the Indiana Office of Community and Rural Affairs (OCRA) Green Infrastructure Curriculum and Training web resources (<https://www.in.gov/ocra/2367.htm>).

B. If the LID track is pursued, the volume reduction provided by these BMPs may be recognized towards determining the post-developed runoff rates and volumes for larger events (up to and including the 100-year event). See **Table 8-8** for extent of runoff reduction recognition allowed for such larger events.

- The volume reduction BMPs work well when they are placed in an appropriate setting. Please see "Applicability and Limitation" discussions in each Fact Sheet for best suited placement of BMP. In order to qualify for recognition, the BMPs must also meet all the following:
 - Be in the common areas and covered by an easement or other agreement that assigns responsibility for its maintenance.
 - Be covered by a maintenance plan and agreement with assurances for the long-term availability of maintenance funds in a form acceptable to CCDB or designee.
 - Be constructed on undisturbed A or well-drained B soils (B/D soils do not qualify) or amended soil with underdrains, as needed. If underdrains are used, the bottom elevations of the underdrains should be above the seasonal high water table. Soil infiltration testing protocol, provided in the appendices provided in the Indiana Office of Community and Rural Affairs (OCRA) Green Infrastructure Curriculum and Training web resources (<https://www.in.gov/ocra/2367.htm>), must be followed to determine if infiltration BMPs are suitable at a site and to obtain the required data (such as soil conditions and depth of seasonal high water table) for infiltration design.
 - Be constructed in an area where the depth of seasonal high water table and any bedrock is more than a minimum of 2 feet (4 feet is desirable) from BMP bottom elevation.

- Be constructed in a manner that any infiltration practices are adequately separated from basement foundations (50 feet up gradient, 10 feet down gradient), on-site septic systems/drainfields (100 feet), wells (50 feet), and other building elements that could be affected by infiltration systems.
 - Be constructed outside of any 1-year (Zone 1) or 5-year (Zone 2) time of travel areas to public water supply wells, as defined by a modeled wellfield delineation performed in compliance with 327 IAC 8-4.1. When such delineation is not available, said practice must be at least 3,000 feet from the nearest public water supply well (unless applicant can demonstrate that the proposed practice will have no impacts on the water quality of the water supply well).
 - Final construction should be completed after the contributing drainage area has been stabilized.
 - Must contain erosion-protection features at the inflow to prevent scouring
 - Must contain a maintenance area near the inlet to collect large debris. Examples include small concrete aprons, catch basin inserts, or similar durable maintenance point.
- When the LID Approach is being pursued in all other aspects of the design but site limitations would not allow permanent volume reduction practices/infiltration, channel protection volume should, at a minimum and as site limitations would allow, be accommodated through distributed storage solutions noted in Table 8-5 that also include underdrains as described in the appropriate Fact Sheets so that at a minimum they can act as both extended detention and filtration practices.
 - **Calculation Methods for Recognizing Impacts of Distributed Storage on Overall Site's Peak Flow Detention Requirements:** when all the stated conditions above are met for volume-reduction distributed storage practices noted in Table 8-5, total volume provided for channel protection within distributed storage units (not to exceed the required channel protection volume calculated in Step 4) may be applied towards the site's overall detention requirements for peak (10-year and 100-year) flow control (see **Table 8-8**). Several methods are available to account for the noted runoff reduction recognition. A few common methods are listed below (other methods not noted below may also be used as appropriate):
 - Method 1: Assume that the provided CPv in the distributed storage units (not to exceed the required CPv calculated in Step 4) will be stored below the detention pond's normal pool (below the lowest outlet). To simulate this condition, all the volumes in the elevation-storage table are increased by the provided CPv, an additional table entry is made as the first row with an artificial lower elevation and with zero for storage, and the reservoir's starting elevation is set at the noted artificial elevation.
 - Method 2: Utilize the "Divert" option of the hydrologic model used to compute the inflow to the pond to simulate the diversion (abstraction) of the provided CPv (not to exceed the required CPv calculated in Step 4) from the detention pond inflow before the remaining flood hydrograph is routed through the detention system. To accomplish this, the model should have capability to simulate diversion with a volume cap option.
 - Method 3: Explicitly model the distributed storage features as a network of storage and conveyance units through the use of computer programs that can correctly model interconnected storage.

Step 6: Provide Additional (as-needed) Extended Detention Practices

- When the LID Approach is being pursued in all other aspects of the design but site limitations would not allow adequate distributed volume reduction/infiltration practices noted in Step 5 (with or without underdrain), then a constructed wetland or a wet-bottom extended detention facility along with incorporation of an appropriate wetland fringe should be utilized as listed in **Table 8-6**. If designed properly, such a facility can be incorporated into a multi-purpose facility to control channel protection volume, water quality volume, and 100-year peak flow rate. Note that since by design conditions of an extended detention facility, 90% of the original volume will be available within 48 hours of each storm event (i.e., a maximum of 36 hours from when the channel protection pool is full), the volume

in the pond associated with the channel protection may be assumed empty for the purpose of peak flow detention analysis discussed in Chapter 6 of these Standards (see Table 8-8).

**Table 8-6
Pre-approved BMPs with Additional, As-needed Extended Detention Runoff Reduction Recognitions
for Channel Protection as Part of LID Approach**

BMP ^A	Runoff Reduction Recognition ^B
Constructed Wetland	The volume of the supplementary extended detention, in lieu of permanent volume reduction, is applied towards meeting Channel Protection Volume requirements so long as only 10% of the maximum stored volume is left in the basin after 36 hours from maximum storage time and no more than 40% from the maximum stored volume is released within the first 12 hours.
Extended Detention Wet/Dry Pond	The volume of the supplementary extended detention, in lieu of permanent volume reduction, is applied towards meeting Channel Protection Volume requirements so long as only 10% of the maximum stored volume is left in the basin after 36 hours from maximum storage time and no more than 40% from the maximum stored volume is released within the first 12 hours.

Notes:

- A. In using and crediting these BMPs, applicants must meet the review criteria located within the discussion of each BMP provided in the appendices provided in the Indiana Office of Community and Rural Affairs (OCRA) Green Infrastructure Curriculum and Training web resources (<https://www.in.gov/ocra/2367.htm>).
- B. If the LID track is pursued, the volume reduction provided by these BMPs may be applied towards determining the post-developed runoff rates and volumes for larger events (up to and including the 100-year event). See Table 8-8 for extent of volume reduction allowed for such larger events.

Step 7: Determine Water Quality Volume and Provide, As-needed, Additional Water Quality BMPs

- The expected treatment of many BMPs applied to LID designs is based on removing solids. Many pollutants are attached to solids or are removed by similar treatment mechanisms. Therefore, removing solids can act as a surrogate for the expected removal of other particulate pollutants. Often multiple BMPs will be necessary to remove successively smaller particle sizes to achieve the highest level of treatment.
- When the CPv is controlled with BMPs that also meet the stormwater quality performance criteria in Section B (including both the required type and also the number of BMP in series), often no additional calculation or BMP implementation is necessary. If the channel protection volume is not controlled through practices that also meet the stormwater quality performance criteria in Section B, calculate the water quality volume that provides for the treatment of the first inch of rainfall on the site's disturbed areas as discussed below.
- The methodology for determining the design water quality volume or rate for the LID Approach is the same as that described for CPv calculation described in Step 4, except the rainfall depth for Water

Quality will be 1 inch instead of the 1-year, 24-hour rainfall depth used for calculating the CPv. A few considerations specific to Water Quality Volume/Rate calculations are as follows:

- Time of Concentration in the case of LID design is the time it takes a drop of water to move from the furthest point in the disturbed area to its discharge from the disturbed area.
- Computer Model: If using acceptable computer models, perform the same procedure as that performed for calculating CPv in Step 4, but for 1 inch of rainfall depth.
- Manual Calculation: If calculating manually, use the following formula:
 - **Runoff Volume (ft³) for each cover type = $Q_v \times 1/12 \times A$**
Where
A = disturbed area of the particular cover type (ft²)
Q_v = Runoff Depth (in) = $(P - 0.2S)^2 / (P + 0.8S)$
P = 1 inch
S = $(1000/CN) - 10$
 - **Peak Runoff Rate (ft³/sec) = $q_u \times A \times Q_v \times 1/43,560$**
Where
A = disturbed area of the particular cover type (ft²)
Q_v = Runoff Depth (in) calculated in previous step
q_u = Unit Peak Discharge (cfs/mi²/in), determined from TR-55 Exhibit 4-II
 - Sum the individual volumes and peak runoff rates to obtain the total design post-development water quality runoff volume and rate.
- Determine the total post-development water quality runoff volume and rate for the entire site's disturbed areas. These are the design post-development water quality runoff volume and rate needing to be treated.
- Select BMPs from the list provided in Table 8-1 that will meet the performance criteria noted in Section B of this Chapter. Often, multiple types of BMPs used in series will be required to provide adequate treatment. Design the BMPs in conjunction with any detention control that is needed for peak rate control of larger floods (100-year), if possible.

Step 8: Complete the LID Approach Utilization Summary Form

- As the final step of the LID Approach, a summary of non-structural and structural BMPs utilized, as part of the LID Approach, in the site design of a particular development site is provided in Table 8-7 and submitted as part of the permit request package.
- The presence of Table 8-7 in the submittal package and the information contained in the form would alert the plan reviewer that the LID Approach is being used to meet the post-construction stormwater quality requirements of the site and that the overall site design as well as peak discharge and detention calculations should be reviewed with the impacts of LID Approach in mind.

**Table 8-7
LID Approach Summary Checklist**

This checklist is a tool to allow both the regulatory agency and the Developer to reference various LID measures implemented within the development in order to meet the development's Post Construction Stormwater Management requirements.					
Project Name:		Engineer:		Developer:	
Total Site Area:		_____		sf	
Proposed Earth Disturbance Area:		_____		sf	
Existing Impervious Area:		_____		sf	
LID Approach Step	Potential BMPs	√	Total Surface Area (sf) of LID Measure/BMP	Plan Pg # of LID Measure	Pg # of Calculations for LID Measure
1. Minimize Disturbed Areas	Protect Sensitive Areas				
	Protect Riparian Buffers				
	Protect Natural Flow Pathways				
	Minimize Total Disturbed Area				
	Reduce Impervious Surfaces				
	Cluster-Type Development				
2. Restore Disturbed Areas	Minimize Soil Compaction				
	Protect Trees in Disturbed Areas				
	Soil Amendment and/or Restoration				
	Native Revegetation				
	Riparian Buffer Restoration				
3. Minimize Imperviousness	Porous Pavement				
	Vegetated Roof				
4. Determine Volume Control Needed for Channel Protection	N/A (calculation step only)		N/A		
5. Provide Distributed Retention/Infiltration Practices	Infiltration Practices*				
	Bio-retention				
	Vegetated Swale				
6. Additional (as-needed) Extended Detention Practices	Constructed Wetland		N/A		
	Extended Detention Wet/Dry Pond		N/A		
7. Additional (as-needed) Water Quality BMPs	Pre-approved BMPs noted in Table 8-1 for conventional method		N/A		
Additional Flood Peak Control (2yr-100yr)	Detention Pond (wet/dry/underground)		N/A		
Total Surface Area of LID Measures			_____ sf		
Proposed Final Impervious Surface Area			_____ sf		
Percent of Total Site Area Covered by LID			_____ %		
Note: Not all LID measures are necessary or appropriate for every site. It is imperative that proper site assessments and due diligence is completed by the Developer and/or Engineer prior to design.					

*: Infiltration Practices include: Infiltration Basins, Subsurface Infiltration Beds or Trenches, and Dry Wells

Summary of Runoff Reduction Recognitions for Water Quality Volume, Channel Protection, and Peak Flow Control Detention Volume for LID approach

As discussed throughout this Section, to encourage LID approach for stormwater management, runoff reduction recognitions towards all three major stormwater management requirements, i.e., Water Quality, Channel Protection, and Peak Runoff Detention, are associated with various BMPs as noted through the above 8-step process. These runoff reduction recognitions are summarized in **Table 8-8**.

**Table 8-8
Summary of Runoff Reduction Recognitions for Pre-approved BMPs Used in the LID Approach**

Implementation Order	DESCRIPTION	POTENTIAL BMPs	RECOGNITION/CREDIT FOR POST-CONSTRUCTION WATER QUALITY CALCULATIONS		RECOGNITION/CREDIT FOR WATER QUANTITY (DETENTION AND STORM DRAIN) CALCULATIONS
			WATER QUALITY VOLUME	CHANNEL PROTECTION VOLUME	
1	Minimize Disturbed Areas	<ul style="list-style-type: none"> Protect Sensitive Areas Protect Riparian Buffers Minimize Total Disturbed Area Protect Natural Flow Pathways Reduce Impervious Surfaces Cluster-Type Development 	Full recognition through allowing to use "disturbed surface area" only for all calculations	Full recognition through allowing to use "disturbed surface area" only for all calculations	Full recognition through allowing CN for the undisturbed, protected area to be calculated based on pre-developed underlying soil types
2	Restore Disturbed Areas	<ul style="list-style-type: none"> Minimize Soil Compaction Protection of Existing Trees within disturbed areas (part of Minimize Total Disturbed Area) Soil Amendment and Restoration Native Revegetation Riparian Buffer Restoration 	Full recognition through allowing CN for the restored/protected area to be calculated based on pre-developed underlying soil types	Full recognition through allowing CN for the restored/protected area to be calculated based on pre-developed underlying soil types	Full recognition through allowing CN for the restored/protected area to be calculated based on pre-developed underlying soil types
3	Minimize Imperviousness	<ul style="list-style-type: none"> Porous Pavement 	Full recognition of perviousness through allowing CN for the application area to be calculated based on a pre-set value (74 instead of 98) AND full recognition of the stored volume (if provided for in the design) and WQ treatment, if designed as a true infiltration practice (no underdrain/ or extended 24-48 hrs release)	Partial (weighted) recognition of perviousness through allowing CN for the application area to be calculated based on a pre-set value (87 instead of 98) AND full recognition of the stored volume (if provided for in the design), if designed as a true infiltration practice (no underdrain/ or extended 24-48 hrs release)	Partial (weighted) recognition of perviousness through allowing CN for the application area to be calculated based on pre-set values (89 for 10-year and 90 for 100-year calculations instead of using 98) and limited recognition of the stored volume (if provided for in the design) up to Channel Protection Volume, on a case by case basis, treated as an underground detention
		<ul style="list-style-type: none"> Vegetated Roof 	Full recognition of perviousness through allowing CN for the application area to be calculated based on a pre-set value (74 instead of 98) AND full recognition of the stored volume (if provided for in the design) and/or WQ treatment if designed for	Partial (weighted) recognition of perviousness through allowing CN for the application area to be calculated based on a pre-set value (87 instead of 98)	Partial (weighted) recognition of perviousness through allowing CN for the application area to be calculated based on a pre-set value 89 for 10-year and 90 for 100-year calculations instead of using 98)
4	Provide Distributed Volume Reduction/Infiltration Practices (or Filtration Practices, if underdrains have to be provided) in Common Areas	<ul style="list-style-type: none"> Infiltration Practices (Infiltration Basin, Subsurface Infiltration Bed, Infiltration Trench, and Dry Well) Bioretention Vegetated Swale 	Full recognition of perviousness through allowing CN for the application area to be calculated based on cover type and underlying soil AND full recognition of the retained volume (if provided for in the design) and/or WQ treatment if designed for	Full recognition of retained volume if designed as true infiltration practice (on appropriate soil and no underdrain/ or extended 24-48 hrs release)	Limited recognition of retained volume (up to the Channel Protection Volume) if designed as true infiltration practice (on appropriate soil and no underdrain/ or extended 24-48 hrs release). Credit for retained volume up to 100-year peak flow rate volume may be granted on a case by case basis for sites with unusually high infiltration rates.
5	Provide, As-needed, Additional Extended Detention Practices in Common Areas	<ul style="list-style-type: none"> Constructed Wetland Extended Detention Wet/Dry Pond 	full recognition of the stored volume (with extended 24-48 hrs release) and/or WQ treatment if designed for	Full Recognition of stored volume (with extended 24-48 hrs release)	Full Recognition of stored volume (with extended 24-48 hrs release)
6	Provide, as needed, Additional Water Quality BMPs	<ul style="list-style-type: none"> Pre-approved BMPs noted in Table 8-1 for conventional method 	Full recognition of WQ treatment	N/A	N/A

G. SPECIAL PROVISIONS FOR “HOT SPOT” LAND USES

For all those projects involving land uses considered to be high pollutant producers or “hot spots” (see **Table 8-9** e.g., vehicle service and maintenance facilities, vehicle salvage yards and recycling facilities, vehicle and equipment cleaning facilities, fleet storage areas for buses, trucks, etc., industrial/commercial or any hazardous waste storage areas or areas that generate such wastes, industrial sites, restaurants and convenience stores, any activity involving chemical mixing or loading/unloading, outdoor liquid container storage, public works storage areas, commercial container nurseries, and some high traffic retail uses characterized by frequent vehicle turnover), additional water quality requirements may be imposed by CCDB or designee in addition to those included in water quality criteria in order to remove potential pollutant loadings from entering either groundwater or surface water systems. These pre-treatment requirements are included in **Table 8-9** and **Table 8-10**.

**Table 8-9
Pre-Treatment options for Stormwater Hot Spots**

Stormwater Hot Spots	Minimum Pre-Treatment Options
Vehicle Maintenance and Repair Facilities	A, E, F, G
Vehicle Fueling Stations	A, D, G
Drive-through Restaurants, Pharmacies, Convenience Stores	B, C, D, I, K
Outdoor Chemical Mixing or Handling	G, H
Outdoor Storage of Liquids	G
Commercial Nursery Operations	I, J, L
Other Uses or Activities Designated by Appropriate Authority	As Required

**Table 8-10
Minimum Pre-Treatment Options**

Minimum Pre-Treatment Options	
A	Oil/Water Separators / Hydrodynamic Separators
B	Sediment Traps/Catch Basin Sumps
C	Trash/Debris Collectors in Catch Basins
D	Water Quality Inserts for Inlets (inspected and cleaned after every significant rainfall event)
E	Use of Drip Pans and/or Dry Sweep Material under Vehicles/Equipment
F	Use of Absorbent Devices to Reduce Liquid Releases
G	Spill Prevention and Response Program
H	Diversion of Stormwater away from Potential Contamination Areas
I	Vegetated Swales/Filter Strips
J	Constructed Wetlands
K	Stormwater Filters (Sand, Peat, Compost, etc.)
L	Stormwater Collection and Reuse (especially for irrigation)
M	BMPs that are a part of a Stormwater Pollution Prevention Plan (SWPPP) under a NPDES Permit

H. CONSTRUCTION SEQUENCING CONSIDERATIONS

BMPs noted in this chapter refer to post-construction BMPs, which continue to treat stormwater after construction has been completed and the site has been stabilized. Installing certain BMPs, such as bioretention areas and sand filters, prior to stabilization can cause failure of the measure due to clogging from sediment. If such BMPs are installed prior to site stabilization, they should be protected by traditional erosion control measures.

In those instances, the construction sequence must require that the pond is cleaned out with pertinent elevations and storage and treatment capacities reestablished as noted in the accepted stormwater management plan.

I. INSPECTION AND MAINTENANCE REQUIREMENTS

Subsequent to successful installation of Post-construction BMPs, they need to be inspected and maintained regularly in accordance with the Operation and Maintenance Manual required to be prepared for each BMP. An operations and maintenance (O&M) manual for all MS4-owned or private infrastructure, including but not limited to pipes, ponds, ditches, and BMPs (when required), shall be submitted for the final plan approval and permit process. The manual will become a maintenance guide for the drainage infrastructure once development is complete. The final O&M manual will be provided to the CCDB or designee in both hard copy and digital formats. The O&M manual maintenance agreement along with a site map showing the BMP locations shall be recorded with the final plat. The O&M manual will include the following:

1. Name, address, business phone number, home phone number, email address, cellular phone number, pager number of owner;
2. Site drawings (8½" by 11" or 11" by 17"), showing both plan and cross-section views, showing the infrastructure and applicable features, including dimensions, easements, outlet works, forebays, signage, etc., as well as an overall site map of the development showing all structures;
3. Guidance on owner-required periodic inspections;
4. Requirement of owner to perform maintenance specified by CCDB or designee inspection, if any;
5. Guidance on routine maintenance, including mowing, litter removal, woody growth removal, signage, etc.;
6. Guidance on remedial maintenance; such as inlet replacement, outlet works maintenance, etc.;
7. Guidance on sediment and trash removal, both narrative and graphical, describing when sediment removal should occur in order to ensure that BMPs and other infrastructure remain effective as water quality and/or quantity control devices;
8. A statement that the CCDB or designee's representatives have the right to enter the property to inspect the infrastructure;
9. A tabular schedule showing inspection and maintenance requirements; and
10. Identification of the property owner as the party responsible for all maintenance, including cost.
11. Identification of the Homeowners Association, if applicable, for eventual transfer of BMP ownership and maintenance responsibilities.

Inspection checklists for various types of BMPs are provided in the appendices provided in the Indiana Office of Community and Rural Affairs (OCRA) Green Infrastructure Curriculum and Training web resources (<https://www.in.gov/ocra/2367.htm>). A sample of the required Stormwater Management Maintenance Agreement is provided in Appendix B. This agreement will need to be further customized, signed, notarized, and recorded so that it can be a part of the property's deed. The maintenance agreement, the O&M Manual, and the Escrow account (described below) shall be transferred to the new owner as the ownership and BMP maintenance responsibilities change hands.

Since the proper perpetual maintenance of post-construction BMPs, especially the green infrastructure, is so crucial to proper operation of such BMPs, in addition to the maintenance agreement discussed above, the developer is required to establish a permanent maintenance escrow account and subsequently transfer it to the future property owner's association or similar entity to cover the cost of annual maintenance of the post-construction BMPs in perpetuity. The escrow account is to be held by an entity acceptable to CCDB or designee.

The established escrow account can be spent solely for sediment removal, structural, biological or vegetative replacement or removal, invasive species or weed management, mulching, major repair, or reconstruction of the stormwater management measures and devices of the particular site plan or subdivision. If stormwater management facilities are not performing adequately or as intended or are not properly maintained, the CCDB or designee, in its sole discretion, may remedy the situation, and in such instances the CCDB or designee shall be fully reimbursed from the escrow account. Escrowed funds may be spent by the association for sediment removal, structural, biological or vegetative replacement or removal, invasive species or weed spraying and/or removal/trimming, mulching, major repair, and reconstruction of the stormwater management facilities; provided that, the CCDB or designee shall first consent to the expenditure. Note that the list of eligible expenses excludes routine mowing, landscaping, pruning, and other similar activities that have traditionally and continue to be expected of the entity controlling the land to fund.

Initially, the developer's contribution shall fund the escrow account. Prior to plat recordation or issuance of construction plan approval/permits, whichever shall first occur, the developer shall pay into the escrow account an amount equal to fifteen (15) per cent of the estimated initial construction cost of the stormwater control facilities. This amount shall remain in the escrow account and shall be transferred to the future property owner's association or similar entity after the developer receives a signed copy of the final Termination Inspection Checklist from the CCDB or designee confirming compliance and the IDEM NOT for the project is filed. Note that the establishment and dedication of the above referenced maintenance escrow account is in addition to the maintenance bond and assurance required by the Ordinance following the issuance of the signed final Termination Inspection Checklist by the CCDB or designee.

Once the signed final Termination Inspection Checklist by the CCDB or designee is issued for the project and the maintenance of the site has been turned over to the property owner/property owner's association or similar entity, the subsequent required annual funding of the escrow account shall be the responsibility of the property owner association. A portion of the annual assessments of the property owner's association shall include an allocation into the escrow account. Any funds drawn down from the escrow account shall be replaced in accordance with the schedule of anticipated work used to create the budget. The property owner's association or similar entity shall report the balance and financial activities of the escrow account to the CCDB or designee on an annual basis in the manner acceptable to the CCDB or designee.

Installation and maintenance of appropriate signage of all green infrastructure BMP sites shall also be required both to alert the maintenance crew and to educate the public.

REFERENCES

Southeast Michigan Council of Governments (SEMCOG), Low Impact Development Manual for Michigan: A Design Guide for Implementers and Reviewers, Detroit, Michigan, 2008.



Chapter Nine

METHODOLOGY FOR DETERMINATION OF REQUIRED SIZING OF BMPs

A. INTRODUCTION

This Chapter describes the acceptable methods for calculating Channel Protection Volume, Water Quality Volume, and Flow-Through BMP Flow Rate associated with Conventional Stormwater Management Approach (acceptable methods associated with the LID Stormwater Management Approach are discussed in Chapter 8). Channel Protection is achieved through retention or extended detention of runoff volume for 1-year, 24-hour storm event. Structural Water Quality treatment is achieved by treating the first inch of rainfall, either through retention/detention BMPs or by Flow-through BMPs. Detention/Retention BMPs impound (pond) the runoff to be treated, while flow-through BMPs treat the runoff through some form of filtration process.

B. RETENTION/DETENTION BMP SIZING

1. Channel Protection Volume

Channel Protection Detention/Retention BMPs must be designed to store the channel protection volume. The channel protection volume, CPv, is the storage needed to retain or detain the runoff to the receiving stream from the 1-year, 24-hour rainfall.

The methodology for calculating the Channel Protection Volume (CPv) for each of site's final outlets using computer models or manual calculation is as follows:

- Computer Model: Use acceptable computer models (listed in Chapter 2) to determine the total runoff volume for the site contributing to each site's outlet, utilizing 1-year, 24-hour rainfall depth with Soil Conservation Service (SCS) type 2 storm distribution, drainage area, and the composite CN calculated for the site, according to the Soil Conservation Service (SCS) CN loss method along with SCS unitless hydrograph methodology.

- o Manual Calculation: If calculating manually, use the following formula:

$$CP_v \text{ (ft}^3\text{)} = Q_v \times 1/12 \times A$$

Where

A = total post-construction site area contributory to each outlet (ft²)

Q_v = Runoff Depth (in) = (P – 0.2S)²/(P + 0.8S)

P = 1-Year, 24 Hr Rainfall (in)

S = (1000/CN) – 10

2. Water Quality Volume

Water Quality Detention BMPs must be designed to store the water quality volume for treatment. The water quality volume, WQ_v, is the storage needed to capture and treat the runoff from the first one inch of rainfall. The water quality volume is equivalent to one inch of rainfall multiplied by the volumetric runoff coefficient (R_v) multiplied by the site area.

A calculation methodology similar to that described for the channel protection volume may be utilized, except that the rainfall depth (P) will be equal to 1, instead of the 1-year, 24-hour depth.

Alternatively, a simpler methodology may be used for calculation of WQ_v as follows:

$$WQ_v = (P)(R_v)(A)/12$$

where:

WQ_v = water quality volume for each site's outlet (acre-feet)

P = 1 inch

R_v = volumetric runoff coefficient

A = area in acres

The volumetric runoff coefficient is a measure of imperviousness for the contributing area, and is calculated as:

$$R_v = 0.05 + 0.009(I)$$

Where:

I is the percent impervious cover

For example, a proposed commercial site will be designed to drain to three different outlets, with the following drainage areas and impervious percentages:

Subarea ID	On-site Contributing Area (acres)	Impervious Area %	Off-Site Contributing Area (acres)
A	7.5	80	0.0
B	4.3	75	0.0
C	6.0	77	0.0

Calculating the volumetric runoff coefficient for subareas A, B and C yields:

$$Rv \text{ (subarea A)} = 0.05 + 0.009(80) = 0.77$$

$$Rv \text{ (subarea B)} = 0.05 + 0.009(75) = 0.73$$

$$Rv \text{ (subarea C)} = 0.05 + 0.009(77) = 0.74$$

The water quality volumes for these three areas are then calculated as:

$$WQv \text{ (subarea A)} = (1'')(Rv)(A)/12 = 0.77(7.5)/12 = 0.47 \text{ acre-feet}$$

$$WQv \text{ (subarea B)} = 0.73(4.3)/12 = 0.26 \text{ acre-feet}$$

$$WQv \text{ (subarea C)} = 0.74(6.0)/12 = 0.37 \text{ acre-feet}$$

Note that this example assumed no offsite sources of discharge through the water quality BMPs. If there were significant sources of off-site runoff (sometimes called runoff for upstream areas draining to the site), the designer would have the option of bypassing off-site runoff around the on-site systems, or the detention BMP should be sized to treat the on-site channel protection volume plus the water quality volume for the off-site sources.

C. FLOW THROUGH BMP SIZING

Flow-through BMPs are designed to treat runoff at a calculated water quality treatment flow rate through the system. Examples of flow through BMPs include catch basin inserts, sand filters, and grassed channels. Another flow through BMP is a manufactured treatment device such as a hydrodynamic separator, manufactured infiltration chambers, or other similar type of device discussed in the Water Quality Devices Fact Sheet (<https://www.in.gov/ocra/2367.htm>)

1. Requirements for Manufactured Treatment Devices

Stormwater Manufactured Treatment Devices (MTD), also known as Hydrodynamic separators are proprietary, and usually include a pollutant-water separation component. The MTD should be sized to treat flows up to, and including, the Water Quality Treatment Rate (Qwq) calculated for each project site outlet. To be acceptable, the MTD should meet the following criteria:

- The MTD must be offline and located upstream of detention facilities (if any).
- The MTD must provide complete and unobstructed access to the entire bottom of the system from grade level, if applicable, for ease of maintenance.
- The MTD, or the treatment train (if applicable) that includes the MTD as one of its components, must have the ability to capture or skim pollutants including but not limited to: floating oils / immiscible materials.
- The MTD, or the treatment train (if applicable) that includes the MTD as one of its components, must have the ability to capture both floating and suspended solid material (trash, organic material, etc.) and other pollutants.
- The MTD shall be a manufactured system currently certified by the New Jersey Department of Environmental Protection (NJDEP). A list of NJDEP- MTDs certified for 50% and 80% TSS removal are provided in a table located at <http://www.nj.gov/dep/stormwater/treatment.html>.

To obtain the maximum flow rate for various models of a MTD that is listed in the NJDEP-certified list, the latest verification report from NJCAT Verification Database must be used. A link to the database is provided right above the NJDEP-certified list table.

In summary, the following steps should be used to determine whether a proposed MTD unit is NJDEP-certified and to determine the accepted maximum flow rate for that unit.

Step 1: Determine if the MTD is NJDEP-certified for 50% treatment rate (when the MTD will be used in a treatment train) or 80% treatment rate (when the MTD will be used alone):

- a) Go to <http://www.nj.gov/dep/stormwater/treatment.html>
- b) Look up the name of the MTD in the first column of the table
- c) Look up the Certified TSS Removal Rate of that MTD in the fourth column

Step 2: Determine the maximum accepted flow rate:

- a) Click the link "Certification" in the second column of the NJDEP-certified list table referenced in Step 1. In some cases, a table of MTD model versus the NJDEP-certified maximum flow rate is included in the certification letter. In that case, skip to sub-step "g)" (below). If not continue to the sub-step "b)" (below)
- b) Click the "Click here" link above the NJDEP-certified list table to access NJCAT Verification Database
- c) Find the name of the MTD manufacturer of interest in first column
- d) Find the latest entry (one with the latest verification date shown in third column) for that particular MTD
- e) Click the report download link in the fourth column
- f) Find the Table in the report (typically towards the end of the report) that lists various MTD model sizes along with the NJDEP 50% (or 80%, if appropriate) TSS Maximum Treatment Flow Rate
- g) The selected model should have a maximum flow rate that is equal or larger than the site's required treatment flow rate as determined in Section C.2 of this Chapter.

Note that the NJDEP-certified manufactured system treatment rates for units not equipped with special filters reflect a standard certified 50% TSS reduction at the listed certified treatment flow rate. Therefore, to achieve the 80% TSS removal requirement, either a treatment train with a conventional listed in Table 8-1 (except for another MTD or a sand filter) must be used or a filtration system must be used instead in accordance with the NJDEP methodology. The treatment train shall not include more than one MTD.

Also, note that multiple inlet or units in series configurations are not accepted unless the NJCAT certification and NJDEP verification is specifically done for such an arrangement.

2. Calculating the Required Treatment Flow Rate (Qwq)

The following procedure should be used to estimate peak discharges for flow through BMPs (adopted from Maryland, 2000). It relies on the volume of runoff computed using the Small Storm Hydrology Method (Pitt, 1994) and utilizes the NRCS, TR-55 Method.

Using the WQv methodology, a corresponding Curve Number (CNwq) is computed utilizing the following equation:

$$CN_{wq} = \frac{1000}{10 + 5P + 10Qa - 10\sqrt{Qa^2 + 1.25QaP}}$$

where:

- CNwq = curve number for water quality storm event
- P = 1" (rainfall for water quality storm event)
- Qa = runoff volume, in inches = 1"×Rv = Rv (inches)
- Rv=volumetric runoff coefficient (see previous section)

Due to the complexity of the above equation, the water quality curve number is represented as a function of percent imperviousness in **Figure 9-1**.

The water quality curve number, CN_{wq}, is then used in conjunction with the standard calculated time-of-concentration, t_c , and drainage area as the basis input for TR-55 calculations. Using the SCS Type II distribution for 1 inch of rainfall in 24-hours, the water quality treatment rate, Q_{wq}, can then be calculated.

REFERENCES

1. Maryland Stormwater Design Manual, Volume II, Appendix D.10, 2000
2. Pitt, R., 1994, Small Storm Hydrology. University of Alabama - Birmingham. Unpublished manuscript. Presented at design of stormwater quality management practices. Madison, WI, May 17-19, 1994.
3. Schueler, T.R. and R.A. Claytor, 1996, Design of Stormwater Filter Systems. Center for Watershed Protection, Silver Spring, MD.
4. United States Department of Agriculture (USDA), 1986. Urban Hydrology for Small Watersheds. Soil Conservation Service, Engineering Division. Technical Release 55 (TR-55).

Figure 9-1
Curve Number Calculation for Water Quality Storm Event

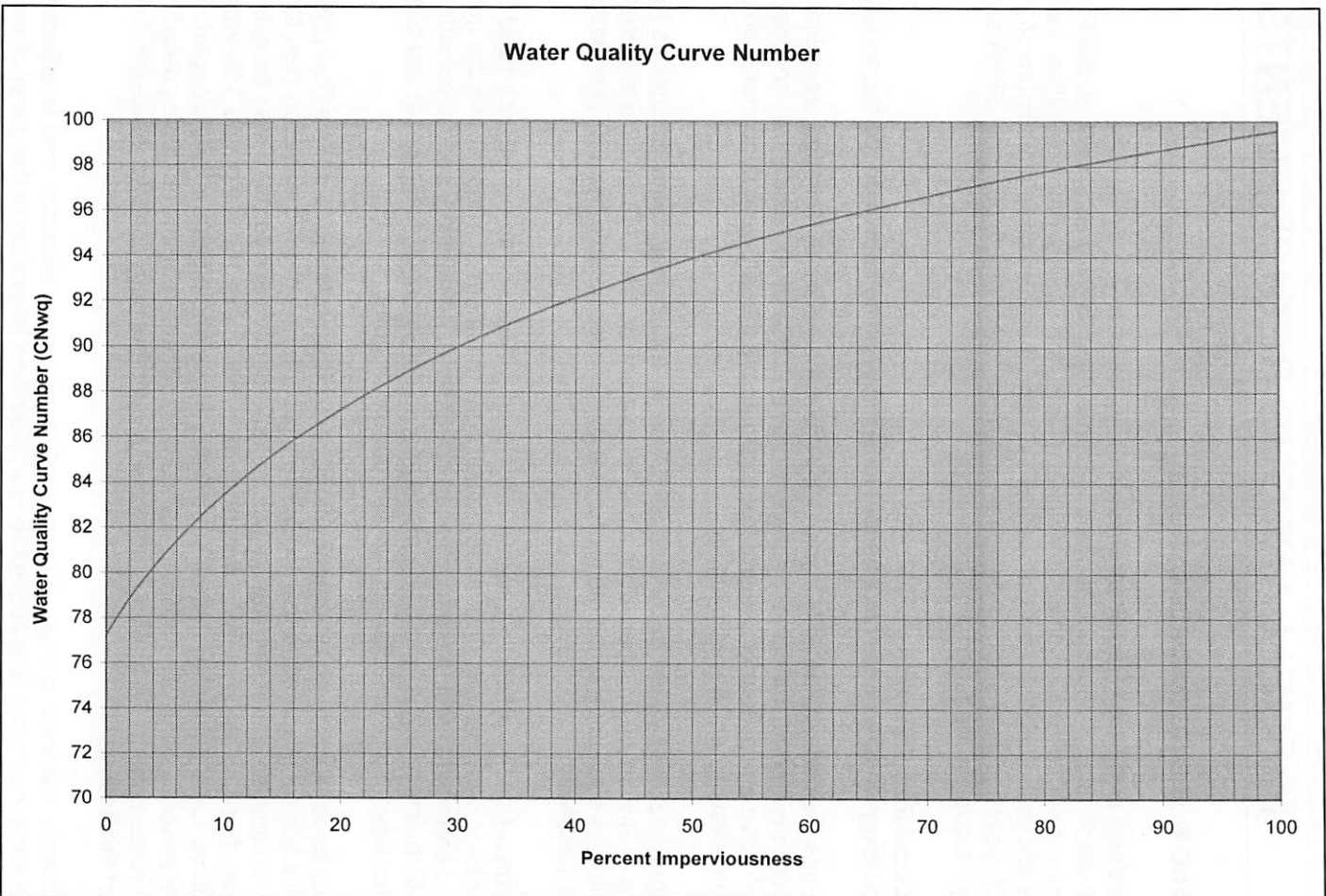



Chapter Ten

MISCELLANEOUS REQUIREMENTS

A. GRADING AND BUILDING PAD ELEVATIONS

Minimum Federal and State Requirements

For all structures located in the Special Flood Hazards Area (SFHA) as shown on the FEMA maps and/or that mapped by the IDNR based on Best Available Data, the Lowest Floor elevation, including basement, shall be at or above the flood protection grade (FPG) and therefore have a minimum of 2 feet of freeboard above the 100-year flood elevation. Additional requirements for buildings within SFHA are contained in the Clark County Floodplain Management Ordinance.

Additional Local Requirements

FPG for all buildings located within or adjacent to SFHA shall be shown on the secondary plat.

For all structures located outside SFHA or an IDNR designated floodplains that are subject to flooding from a detention/retention pond, the lowest adjacent grade (LAG) of all residential, commercial, or industrial buildings shall have a minimum of 2 feet of freeboard above the 100-year flood elevation or the emergency overflow weir elevation, whichever is higher.

For all structures located inside or outside SFHA or an IDNR designated floodplains that are subject to flooding from a stream or an open ditch or other waterway, the LAG of all residential, commercial, or industrial buildings shall have a minimum of 2 feet of freeboard above the 100-year flood elevation of that open ditch or waterway.

For all structures fronting a flooding source other than a swale or an emergency flood route, the floor of any basements or crawl spaces (if provided) shall be a minimum of 1 foot above the normal pool level (if pond) or the 2-year flood level (if a stream or an open ditch). In addition, special considerations, based on detailed geotechnical analysis, should be made prior to considering placement of any basement below the 100-year flood elevation of an adjacent flooding source or pond.

For all structures adjacent to an emergency flood route (also referred to as overflow path/ponding areas), the minimum adjacent grade of the portion of the structure (the ground elevation next to the building after construction is completed that sits adjacent to the emergency flood route or may be subject to flooding by the emergency flood route) shall be a minimum of 1 foot above the estimated 100-year elevation of the emergency flood route assuming that all stormwater inlets and pipes are fully clogged, with no discharge into the storm sewer system. The building adjacent grade requirements (including default elevations above the overflow route bottom) for buildings adjacent to overflow path/ponding areas are further discussed in Chapters 4 of this Manual.

For all structures adjacent to a road, the building's lowest entry elevation that is adjacent to and facing a road shall be a minimum of 2 feet above the road elevation (elevation of the gutter at the center of the lot) so that the road drainage is not directed against the building.

There shall be a positive slope drainage away from the building with maximum yard slopes that are 3:1 where soil has been disturbed during construction processes. Finished floor elevation or the lowest building entry elevation must be no less than 6 inches above finished grade around the building.

In addition to any other provisions in the Ordinance or these Standards, no buildings shall be placed within

25 feet from the top of the bank of any existing or proposed stream, drain, or watercourse, regardless of the contributing drainage area or the bank height.

B. LOT DRAINAGE

All lots shall be laid out so as to provide drainage away from all buildings, and individual lot drainage shall be coordinated with the general stormwater drainage pattern for the subdivision. Drainage shall be designed so as to avoid the concentration of stormwater runoff from a lot onto adjacent lots. Each lot owner shall maintain the lot grade, as it relates to stormwater drainage, in compliance with the approved construction plans.

No part of the lot area of any lot may contain land that is utilized as retention or detention facility or drainage pond, contains a watercourse, or is within a floodway. Where a watercourse separates the buildable area of the lot from the street by which it has access, provisions shall be made for the installation of a culvert or other appropriate structure, as approved by the CCDB or designee. If a subdivision contains an existing or to be developed waterbody, watercourse, or portion thereof, appropriate documentary assurances acceptable to the CCDB or designee shall be provided for the maintenance of such waterbody or watercourse.

It shall be the property owners' responsibility to maintain the natural features on their lots and to take preventive measures against any and all erosion and/or deterioration of natural or manmade features on their lots.

C. ACCEPTABLE OUTLET AND ADJOINING PROPERTY IMPACTS POLICIES

Design and construction of the stormwater facility shall provide for the discharge of the stormwater runoff from off-site land areas as well as the stormwater from the area being developed (on-site land areas) to an acceptable outlet(s) (as determined by the CCDB or designee) having capacity to receive upstream (off-site) and on-site drainage. A Roadside Ditch is generally not considered an adequate outlet. The flow path from the development outfall(s) to a Clark County storm drain, or natural watercourse (as determined or approved by the CCDB or designee) shall be provided on an exhibit that includes topographic information. Any existing field tile encountered during the construction shall also be incorporated into the proposed stormwater drainage system or tied to an acceptable outlet.

If an adequate outlet is not located on site, then off-site drainage improvements may be required. Those improvements may include, but are not limited to, extending storm sewers, clearing, dredging and/or removal of obstructions to open drains or natural water courses, and the removal or replacement of undersized culvert pipes as required by the CCDB or designee.

D. DEVELOPMENT WITHIN FLOODWAYS AND FLUVIAL EROSION HAZARD CORRIDORS

Regulatory Floodway and Fluvial Erosion Hazard (FEH) Corridors along any natural stream watercourse or a drain are considered Impact Drainage Areas and must be preserved to the extent possible to minimize flooding and erosion impacts within the stream system.

Basis for Establishing Floodways

The regulatory floodway along Clark County streams are established as detailed in the latest edition of the Clark County Floodplain Management Ordinance.

Basis for Establishing Fluvial Erosion Hazard (FEH) Corridors

The Indiana Silver Jackets Hazard Mitigation Task Force has initiated a multi-agency program to identify, study and provide mitigation planning resources for communities who would like to adopt Fluvial Erosion Hazard (FEH) avoidance strategies. The resources provided by this project enable individuals and communities to better recognize areas prone to natural stream-erosion processes and adopt strategies to avoid FEH-related risks. The FEH resources define approximate setbacks for communities to better manage river corridors. The setbacks vary based on the stream's recent migration history (actively migrating or relatively stationary).

For actively migrating and relatively stationary streams, a GIS analysis algorithm generated bankfull width values for each stream segment using regional curves that are based on drainage area within each physiographic region in Indiana. For relatively stationary streams, the analysis used these values to create buffer zones of at least one bankfull width on each side (a total corridor width of 3 times bankfull width) or 100 feet on each side of the stream centerline, whichever is greater. For actively migrating streams, GIS generated a total corridor width of 8 times bankfull width, which was manually edited and refined to reflect the digital elevation model and stream meander evidence.

It should be noted that the FEH corridors were created at a map scale of approximately 1:10,000 to 1:15,000. The depicted areas were not meant to be accurate beyond providing an approximate boundary of potential stream migration. A data layer containing FEH Corridors along Indiana streams is currently hosted by IDNR-Division of Water on their mapping portal currently at: <https://indnr.maps.arcgis.com/apps/webappviewer/index.html?id=43e7b307a0184c7c851b5068941e2e23>. The IDNR website notes that, due to its level of detail, this data is not intended for use in project design or parcel level site analysis and that a more detailed analysis of the localized geology and fluvial mechanics is necessary for the proper evaluation of the fluvial erosion hazard.

Despite its inherent level of accuracy, the FEH corridor map created by the Indiana Silver Jackets constitutes the best available data in Clark County and is the basis for regulating development within these corridors by CCDB or designee. A scaled version of the Clark County FEH corridor map is available from the Clark County GIS website. More detailed mapping than that used as part of the Indiana Silver Jackets erosion hazard mapping program may be provided by the applicant if it is based on detailed field assessment acceptable to the CCDB or designee.

Special Requirements within Floodways and FEH Corridors

No disturbance (fill or excavation) associated with a new development or redevelopment is permitted within FEH corridors or regulatory floodways, unless such modifications are part of a stream-wide restoration plan or a watershed master plan. This restriction does not apply to stormwater or tile outfalls. Any streambank stabilization effort within an FEH corridor shall require prior review by the CCDB or designee to safeguard against potential negative impacts on other properties or on the stream morphological system.

E. ADDITIONAL CONSIDERATION FOR DEVELOPMENT WITHIN OR ADJACENT TO BLUFF ZONES AND STEEP SLOPES

In addition to riverine erosion hazards that exist due to lateral migration of streams as discussed in Section D (above), there are hazardous areas along many bluffs and steep slopes existing in Clark County. For the purpose of these Standards, Bluff is defined as a natural topographic feature having:

- a. A slope that rises at least 25 feet and the grade of the slope averages 30 percent or greater, measured over a horizontal distance of 25 feet, from the toe of the slope to the top of the slope. Where the slope begins below the ordinary high water level, the ordinary high water level is the toe of the slope. See **Figure 10-1**; or

- b. A natural escarpment or cliff with a slope that rises at least ten feet above the ordinary high water level or toe of the slope, whichever is applicable, to the top of the slope, with a slope of 75 degrees or greater. See **Figure 10-2**.

These bluffs exist in many places and do not have to be necessarily along a permanent stream. They may be along the rivers (but sometimes outside the floodway and FEH zones) or along many headcut channels and developing ravines in Clark County that may be tributary to various streams. To prevent buildings from damage due to natural slope adjustment next to bluffs, a minimum of 40 feet of landward setback shall be required from top of the bluff as illustrated in Figures 10-1 and 10-2. If a floodway or FEH is also present on the site, the most landward limit shall govern.

The definition of other terms shown in Figures 10-1 and 10-2 are as follows:

- Bluff impact zone: A bluff and land located within 20 feet of the bluff.
- Bluffline: A line delineating the top of the bluff. More than one bluffline may be encountered proceeding landward from the river.
- Toe of Bluff: A line along the bottom of a bluff, requiring field verification, such that the slope above the line exceeds 30 percent and the slope below the line is 30 percent or less, measured over a horizontal distance of 25 feet.
- Top of Bluff: A line along the top of a bluff, requiring field verification, such that the slope below the line exceeds 30 percent and the slope above the line is 30 percent or less, measured over a horizontal distance of 25 feet.

Where principal structures exist on the adjoining lots on both sides of a proposed building site, the minimum setback may be altered to conform to the average of the adjoining setbacks.

In addition to structure setback noted above, with the exception of erosion control practices sanctioned by or approved by the CCDB or designee, no land disturbance (fill or excavation) shall be allowed within a Bluff Impact Zone.

Also note that the minimum setback required in these standards is just that: a minimum, which is based on national experience. When buildings or other infrastructure is proposed near bluffs or steep slopes, the applicant is encouraged to seek a detailed geotechnical evaluation that may result in needing to have a larger setback or have special provisions even when the slopes are gentler than that regulated in these Standards.

**Figure 10-1
Bluff and Bluff Impact Zone**

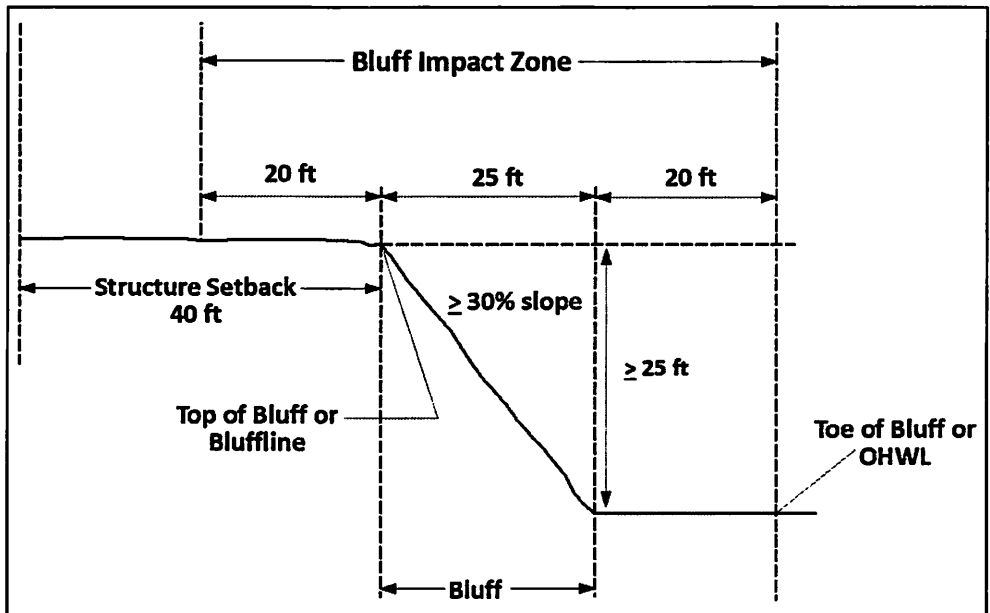

**Figure 10-2
Natural Escarpment Bluff and Bluff Impact Zone**

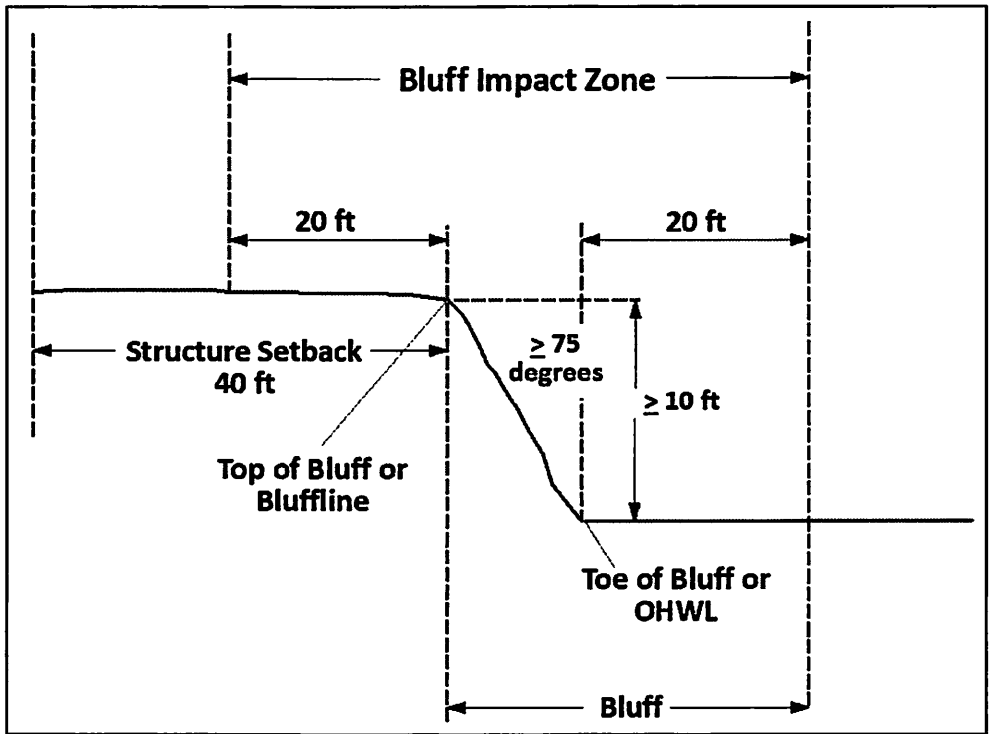

F. FLOODPLAIN AVOIDANCE / NO NET LOSS FLOODPLAIN STORAGE POLICY

Floodplains exist adjacent to all natural and man-made streams, regardless of contributing drainage area or whether they have been previously identified or mapped. Due to potential impacts of floodplain loss on peak flows in streams and on the environment, floodplains are considered Impact Drainage Areas and disturbance to these areas should be avoided. When the avoidance of floodplain disturbance is not practical, the natural functions of the floodplain should be preserved to the extent possible.

In an attempt to strike a balance between the legitimate need for economic development within the Clark County jurisdictional area and the ever-increasing importance of and the need to preserve the natural functions of floodplains to the extent possible (especially given the ongoing and projected climate change impacts), compensatory excavation equivalent to the floodplain storage lost shall be required for all activities within area inundated by the 100-year flood elevation along floodplain of streams located in Clark County where drainage area of the stream is equal to or larger than one square mile. The CCDB or designee may alter the compensation ratio, based on extenuating circumstances, for a specific project.

General Requirements

Note that by definition, compensatory storage is the replacement of the existing floodplain and, in rare exceptions, the floodway storage lost due to fill. Compensatory storage is required when a portion of the floodplain is filled, occupied by a structure, or when as a result of a project a change in the channel hydraulics occurs that reduces the existing available floodplain storage. Compensatory storage must:

- Be provided regardless of whether the flooding source is mapped or whether flood elevations are published or not. When flood elevations are not available for a flooding source that has a drainage area equal to or larger than one (1) square mile (640 acres), the applicant is to determine the 10-year and 100-year flood elevations at the site and get them approved by the IDNR prior to use for floodplain compensation calculations.
- Equal at least 1 times the volume of flood storage lost below the 10-year elevation and storage lost between 10-year and 100-year flood elevations;
- Be operational prior to placement of fill, structures, or other materials temporarily or permanently placed in the regulatory floodplain;
- Be provided in the immediate vicinity of the flood storage lost, where practical;
- Be provided in such a way to mimic as close as possible the function provided by the lost floodplain storage. If the floodplain storage is to be lost outside the active flow conveyance path, then it must be compensated for outside the flow conveyance path (e.g., a flood conveyance shelf/2-stage ditch, while improving conveyance and erosion, is not an appropriate compensation for floodplain storage lost in the floodway fringe area).
- Be provided in addition to the site retention/detention volume; and
- Drain freely and openly to the waterway.

Compensatory storage is also required to be provided incrementally such that:

- All floodplain storage/conveyance capacity lost within the floodway shall be compensated for within the floodway;
- All floodplain storage lost within the floodway fringe shall be compensated for within the floodway fringe;
- All floodplain storage lost below the existing 10-year flood elevation shall be compensated for below the proposed 10-year flood elevation; and
- All floodplain storage lost above the existing 10-year flood elevation shall be compensated for above the proposed 10-year flood elevation.

Note that compensatory storage is required for activities in the regulatory floodplain. There is no threshold to compensatory storage; any volume of fill requires compensatory storage be provided. However, the compensatory storage requirement does not apply to specific activities in the regulatory floodplain, such as the floodproofing of an existing building, where the floodproofing measures such as berms or floodwalls are within 10 feet of the building, or crossing improvements, where artificially created storage is lost due to a reduction in head loss.

Computing Compensatory Storage

Computations must show 1 times compensation for floodplain storage volume lost for 10-year and 100-year storm events. Storage lost between the existing ground and the existing 10-year flood elevation must be compensated by providing 1 time the amount lost and be placed between the existing ground elevation and the proposed 10-year floodplain elevation. Storage lost between the existing 10-year and the existing 100-year elevation must be compensated by providing 1 time the amount lost and be placed between the proposed 10-year elevation and proposed 100-year elevation.

When preparing a grading plan, thought should be given to how compensatory storage will be quantified. The most common methodology is the use of cross sections and the "average end area method". The following requirements should be followed when preparing cross sections:

1. Prepare a detailed topographic survey tied to North American Vertical Datum of 1988 and the Clark County Survey Control Network benchmarks.
2. Locate cross sections parallel to each other and perpendicular to a reference line, often times a property line or fence line. Cross sections used in a hydraulic model are always perpendicular to flood flows, and not always parallel to each other. Therefore, these are often not suitable for computing flood fringe compensatory storage volumes.
3. Plot cross sections at a standard engineering scale so as to allow the reviewer to verify areas. Horizontal scale should be a maximum of 1"=50' and vertical scale should be a maximum of 1"=5', or as approved by the County.
4. Show existing grades, proposed grades, existing and proposed 10-year flood elevations, existing and proposed 100-year flood elevations, normal water level, a reference line, and floodway limits on the cross sections on the plans.
5. Locate cross sections no more than 150 feet apart, with a minimum of three cross sections per cut/fill area, or as necessary to accurately quantify cuts and fills.
6. Locate cross sections to pick up critical features such as berms, ditches, and existing and proposed structures.
7. Each cross section should be numbered or lettered and referenced on the plans.

This information is then utilized to compute the areas of cut and fill. A sample grading plan, a typical cross section, and associated compensatory storage calculations for the 10-year flood are provided on **Figures 10-3, Figure 10-4, and Table 10-1**, respectively.

Volume of Fill between cross sections are calculated by finding the average fill cross sectional area and multiplying it by the distance between the two cross sections. For example, the fill volume between cross sections A and B is calculated as follows:

$$\begin{aligned}\text{Average Fill Area} &= (\text{Fill Area "A"} + \text{Fill Area "B"})/2 = (0 \text{ ft}^2 + 100 \text{ ft}^2)/2 = 50 \text{ ft}^2 \\ \text{Volume of Fill} &= (\text{Average Fill Area}) \times (\text{Distance}) = (50 \text{ ft}^2) \times (150 \text{ ft}) = 7,500 \text{ ft}^3\end{aligned}$$

Once the total volume of fill placed, for this example, between the 0- and 10-yr flood elevations is determined, the total required compensatory storage can be calculated and compared against the total compensatory storage volume provided by the design as shown in the table. For this example:

$$\text{Required Compensatory Storage} = (1) \times (\text{Total Volume of Fill}) = (1) \times (36,250 \text{ ft}^3) = 36,250 \text{ ft}^3$$

Figure 10-3- Example Compensatory Storage Grading Plan

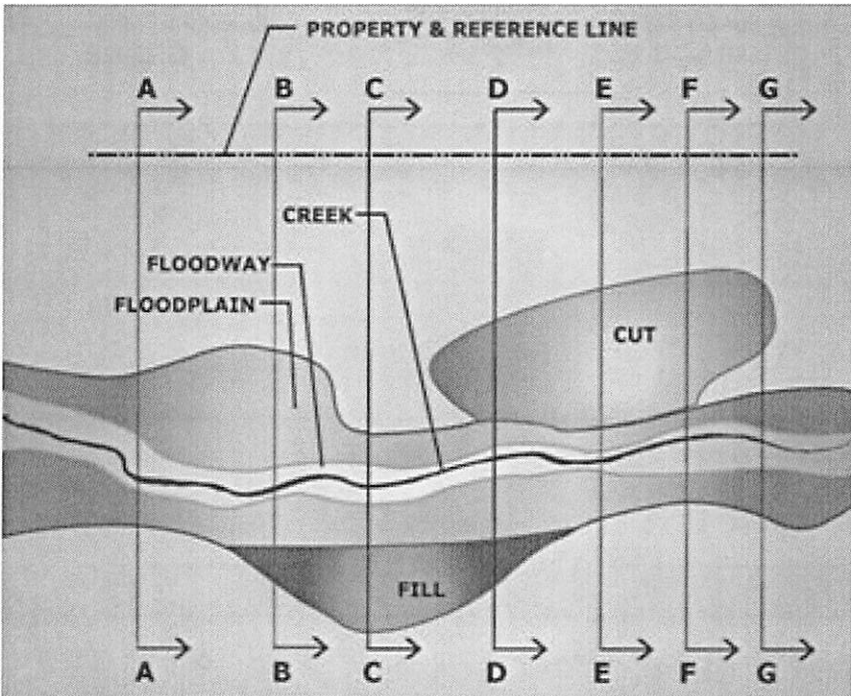

* Not to Scale & Topography not shown for clarity.

Figure 10-4 – Example Cross Section D-D

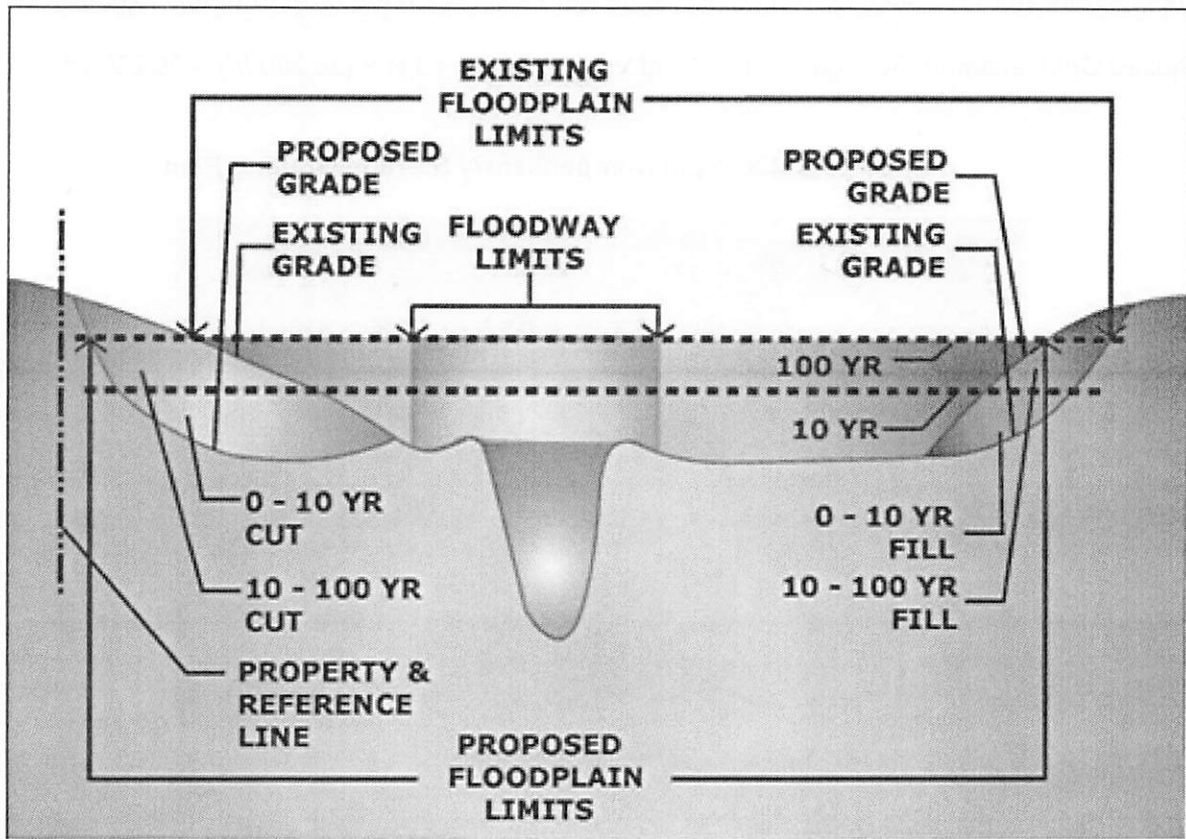

Table 1 - Example Compensatory Storage Calculations for 0-10 year event

Cross Section	Distance Between Sections (ft.)	Fill Area (sq. ft.)	Average Fill Area (sq. ft.)	Volume of Fill (cu. Ft.)	Cut Area (sq. ft.)	Average Cut (sq. ft.)	Volume of Cut (cu. Ft.)
A		0			0		
	150		50	7,500		0	
B		100			0		
	90		125	11,250		20	1,800
C		150			40		
	100		125	12,500		65	6,500
D		100			90		
	100		50	5,000		100	10,000
E		0			110		
	100		0	0		120	12,000
F		0			130		
	85		0	0		85	7,225
G		0			40		
Total Fill				36,250	Total Cut		37,525

Since the total amount of cut provided (37,525 ft^3 as shown in the table) is larger than that required (36,250 ft^3), the design meets the compensatory storage requirement for the 10-year flood. An additional table and calculation should be completed for the flood storage between the 10-year and 100-year flood elevation in a similar manner to determine whether the design meets the compensatory storage requirement for the area above the 10-year flood elevation.

Location of Compensatory Storage

Compensatory storage must be located on-site and adjacent to or opposite the areas filled or occupied by a structure. In those rare instances when compensatory storage cannot be located adjacent to or opposite to the areas filled or occupied, engineering computations demonstrating that hydraulically equivalent compensatory storage has been provided in a nearby area in the watershed is required. These computations must show that no increase in flood flows or flood depths will result as a result of the location of the proposed compensatory storage.

Compensatory storage must be constructed to drain freely and openly to watercourses. In some rare cases it may be necessary to install pipes to construct and/or operate a compensatory storage basin. This may occur when site constraints, such as a roadway or sidewalk, separate the waterway from the compensatory storage area. This is illustrated in the top half of **Figure 10-5**.

Another scenario may occur when a site cannot meet the incremental storage requirements discussed in this document. If incremental storage requirements from the 10-year to 100-year elevations cannot be met, pipes could be installed with a flap gate to prevent the water from entering from the stream bed at lower elevations. The berm could then be set at the elevation of the 10-year flood elevation, thus allowing the storage to only become effective above the 10-year flood elevation. This is illustrated in the bottom half of the illustration in **Figure 10-5**.

The use of pipes in compensatory storage will require approval by the County. Pipes must be a minimum of 15 inches in diameter so as to allow water to enter and exit freely with a minimum head differential. If the compensatory storage is proposed to be combined with detention, it must be demonstrated the compensatory storage and detention do not interfere with one another.

Figure 10-5 – Example of Compensatory Storage Connection to Stream through Pipe

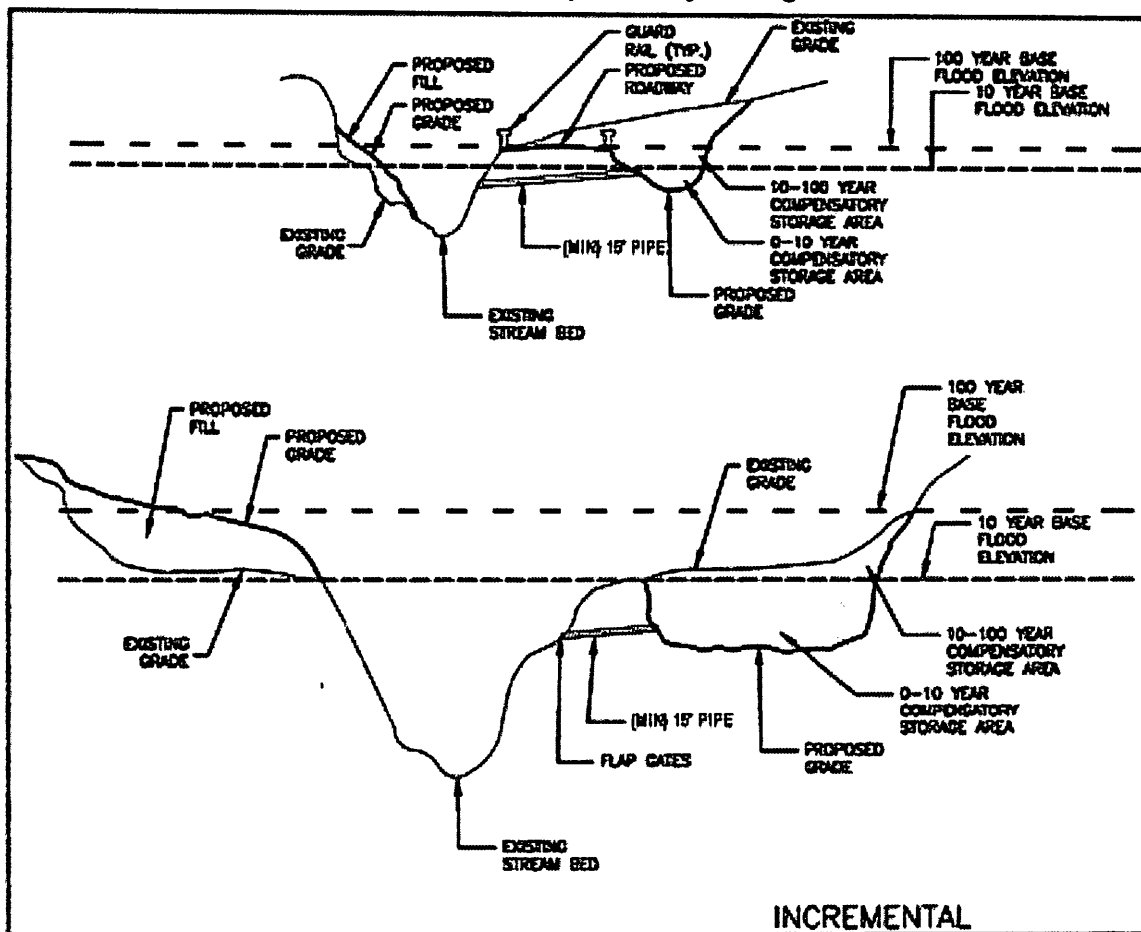

Compensatory Storage in the Regulatory Floodway

Only fill associated with appropriate uses of the regulatory floodway may be allowed to be placed within the limits of the floodway. When in rare circumstances, fill is allowed, all provisions discussed above relating to compensatory storage must be met in addition to the items discussed below.

- Any fill placed within the existing floodway must be compensated for within the proposed floodway.
- All floodway storage lost below the existing 10-year base flood elevation shall be replaced below the proposed 10-year base flood elevation.
- All floodway storage lost between the existing 10-year flood elevation and the existing 100-year flood elevation shall be replaced between the proposed 10-year and proposed 100-year flood elevation.

Should excavation within a floodway be allowed in special circumstances, there shall be no reduction in floodway surface area as a result of a floodway modification, unless such modification is part of a stream-wide plan or necessary to reduce flooding at an existing structure.

G. POLICY ON DAMS AND LEVEES

Dams and levees have the potential for significant, sometimes catastrophic consequences should they fail. In order to minimize the potential for loss of life and public safety, decrease the potential for increased flood

damage and disaster costs, and safeguard the downstream property rights, the following shall be required by the CCDB or designee for any proposed new or improvements to any existing dam or levee. These requirements are in addition to what is normally required for other development subject to this Ordinance and/or that required by State or Federal agencies.

1. Design of dams shall follow the requirements of the latest edition of IDNR-Division of Water "General Guidelines for New Dams and Improvements to Existing Dams in Indiana" as well as principles provided in the latest edition of "Indiana Dam Safety Inspection Manual".
2. Design of levee/floodwalls shall follow the FEMA requirements and guidelines provided in 44 CFR Section 65.10 and USACE Engineer Manual 1110-2-193, Design and Construction of Levees.
3. An Incident and Emergency Action Plan (IEAP), including a detailed dam breach inundation map, shall be developed in accordance with the template provided in the latest edition of "Indiana Dam Safety Inspection Manual" and submitted to the CCDB or designee. The detailed dam breach inundation map referenced in this paragraph shall be developed for both "Sunny Day Breach" Scenario (breach during normal loading conditions) and for maximum loading condition with breach assumed to occur as the spillway system is passing the Spillway Design Flood associated with the dam ("SDF + Breach" Scenario).
4. Unless the "Sunny Day Breach Inundation Area" is entirely contained within the applicant's property and/ or contained within the existing 100-year floodplain, a copy of recorded flood inundation easement or a recorded written consent for every property within the potential "Sunny Day Breach Inundation Area" shall be submitted to the CCDB or designee. Also required is the ownership or recorded easement of all property around the lake with an elevation below the top of the dam. In addition, all the affected property owners whose properties are located within the "SDF + Breach Inundation Area" must be notified of a hearing relevant to the proposed added flooding risk, should such a man-made structure suffer a catastrophic failure. Notification of the time and place of the hearing shall be made in person or by certified mail at least five (5) to ten (10) days prior to the hearing. Proof of notice to each landowner shall be filed by affidavit with the CCDB or designee prior to the hearing.
5. A copy of a Management and Maintenance Plan for the proposed dam or levee developed in accordance with the latest edition of "Indiana Dam Safety Inspection Manual" shall be submitted to the CCDB or designee.
6. Unless the dam is subject to and regulated by IDNR, following the permitting and construction of the dam or levee, a copy of a formal periodic inspection report prepared in accordance with the recommendations contained in the latest edition of "Indiana Dam Safety Inspection Manual" shall be submitted to the CCDB or designee along with evidence that the identified maintenance deficiencies have been corrected. The inspection report has to be submitted as it gets completed in accordance with the inspection frequency recommended in the latest edition of "Indiana Dam Safety Inspection Manual".

H. REQUIREMENTS ASSOCIATED WITH PROPOSED DEVELOPMENTS DOWNSTREAM OF DAMS

As indicated in the previous section, dams have the potential for significant, sometimes catastrophic consequences should they fail. Placing new development downstream of an existing dam does not only expose the future residents or users of the newly developed areas to a potential new significant risk, but could also have an impact on the hazard rating of the dam itself, which can in turn make the dam non-compliant with the state and federal standards. In order to minimize the potential for loss of life and public safety, decrease the potential for increased flood damage and disaster costs, and safeguard the upstream dam owner's rights, the following shall be required by the CCDB or designee for any proposed new

development or redevelopment downstream of an existing dam. These requirements are in addition to what is normally required for new development or redevelopment subject to these Standards.

1. Dam breach inundation maps have been created for several existing dams within the State of Indiana by the dam owners, IDNR, or others as part of development of individual IEAPs for these dams. When the development location is suspected by the applicant or the CCDB or designee to be within an existing dam's breach inundation zone, the applicant is required to include a copy of the breach inundation mapping associated with that dam as part of its stormwater management permit application. To locate such a mapping, the applicant should contact the dam owner, IDNR- Division of Water, CCDB or designee, or other agencies to obtain the breach inundation map for the dam, if available. If no dam breach inundation map can be located for the dam, it will be the applicant's responsibility to produce a CCDB or designee-acceptable dam breach mapping either through directly contracting with a qualified engineer or through funding the production of such a map by the CCDB or designee review consultant in accordance with standards and guidelines established by the IDNR-Division of Water.
2. If the location of the proposed development falls within the dam breach inundation zone on the map discussed under Item i (above), additional requirements as determined by CCDB or designee may be imposed before a permit is issued and the development is allowed to occur. The noted additional requirements depend on several variables and are expected to vary case by case. Typical requirements could include relocating a portion or all of the proposed development to areas outside of the dam breach inundation zone, cost-sharing with the dam owner in necessary upgrades to the dam as a result of a potential hazard classification increase, addition of structural protection measures (such as flood protection levees), additional freeboard requirements, development and periodic exercise of warning and evacuation plans, and other measures considered necessary by CCDB or designee to minimize the potential for loss of life and public safety, decrease the potential for increased flood damage and disaster costs, and safeguard the upstream dam owner's rights.

H. REQUIREMENTS ASSOCIATED WITH PROPOSED SOLAR FARMS

Solar development has ... (to be added when finalized)

APPENDIX A

ABBREVIATIONS AND DEFINITIONS



ABBREVIATIONS AND DEFINITIONS

ABBREVIATIONS

BFE	Base Flood Elevation
BMP	Best Management Practice
CFS	Cubic Feet Per Second
CLOMR	Conditional Letter of Map Revision (from FEMA)
CLOMR-F	Conditional Letter of Map Revision Based on Fill (from FEMA)
CN	Curve Number
COE	United States Army Corps of Engineers
CSMP	Comprehensive Stormwater Management Program
CSO	Combined Sewer Overflow
CWA	Clean Water Act
ERM	Elevation Reference Mark
E&SC	Erosion and Sediment Control
EPA	Environmental Protection Agency
ETJ	Extraterritorial Jurisdiction
FBFM	Flood Boundary and Floodway Map
FEH	Fluvial Erosion Hazard
FEMA	Federal Emergency Management Agency
FHBM	Flood Hazard Boundary Map
FIRM	Flood Insurance Rate Map
FIS	Flood Insurance Study
FPG	Flood Protection Grade
FPS	Feet Per Second
GIS	Geographical Information System
GPS	Global Positioning System
HGL	Hydraulic Grade Line
HHW	Household Hazardous Waste
HUC	Hydrologic Unit Code

IDEM	Indiana Department of Environmental Management
IDNR	Indiana Department of Natural Resources
INDOT	Indiana Department of Transportation.
LAG	Lowest Adjacent Grade
LID	Low Impact Development
LOMA	Letter of Map Amendment (from FEMA)
LOMR	Letter of Map Revision (from FEMA)
LOMR-F	Letter of Map Revision Based on Fill (from FEMA)
MCM	Minimum Control Measure
MS4	Municipal Separate Storm Sewer System
NAVD	North American Vertical Datum of 1988
NFIP	National Flood Insurance Program
NGVD 1929	National Geodetic Vertical Datum of 1929
NRCS	USDA-Natural Resources Conservation Service
NPDES	National Pollutant Discharge Elimination System
NPS	Non-point source
POTW	Publicly Owned Treatment Works
SFHA	Special Flood Hazard Area
SWCD	Soil and Water Conservation District
SWPPP	Stormwater Pollution Prevention Plan
SWQMP	Stormwater Quality Management Plan
Tc	Time of Concentration
TMDL	Total Maximum Daily Load
TN	Total Nitrogen
TP	Total Phosphorus
TSS	Total Suspended Solids
USCS	Unified Soil Classification System
USDA	United States Department of Agriculture
USFWS	United States Fish and Wildlife Service

DEFINITIONS

Acre-Foot (AF). A measure of water volume equal to the inundation of a flat one-acre area to a depth of one foot (43,560 cubic feet).

Administering authority. The designated unit of government given the authority to issue permits.

Agricultural land disturbing activity. Tillage, planting, cultivation, or harvesting operations for the production of agricultural or nursery vegetative crops. The term also includes pasture renovation and establishment, the construction of agricultural conservation practices, and the installation and maintenance of agricultural drainage tile.

Agricultural land use conservation practices. Use of land for the production of animal or plant life, including forestry, pasturing or yarding of livestock, and planting, growing, cultivating, and harvesting crops for human or livestock consumption. Practices that are constructed on agricultural land for the purposes of controlling soil erosion and sedimentation. These practices include grass waterways, sediment basins, terraces, and grade stabilization structures.

Amortization Period. The length of time used to repay a debt or mortgage or to depreciate an initial cost.

Antecedent Runoff Condition. The index of runoff potential before a storm event. The index, developed by the Soil Conservation Service (SCS), is an attempt to account for the variation of the SCS runoff curve number (CN) from storm to storm.

Backflow Preventer. Device that allows liquids to flow in only one direction in a pipe. Backflow preventers are used on sewer pipes to prevent a reverse flow during flooding situations.

Backwater. The rise in water surface elevation caused by some obstruction such as a narrow bridge opening, buildings or fill material that limits the area through which the water shall flow.

Base Flood Elevation. The water surface elevation corresponding to a flood having a one percent probability of being equaled or exceeded in a given year.

Base Flood. See "Regulatory Flood".

Base Flow. Stream discharge derived from groundwater sources as differentiated from surface runoff. Sometimes considered to include flows from regulated lakes or reservoirs.

Basement. A building story that is all or partly underground but having at least one-half of its height below the average level of the adjoining ground. A basement shall not be counted as a story for the purpose of height regulations.

Benchmark. A marked point of known elevation from which other elevations may be established.

Best Management Practices. Design, construction, and maintenance practices and criteria for stormwater facilities that minimize the impact of stormwater runoff rates and volumes, prevent erosion, and capture pollutants.

Buffer Strip. An existing, variable width strip of vegetated land intended to protect water quality and habitat.

Building. See "structure".

Capacity of a Storm Drainage Facility. The maximum flow that can be conveyed or stored by a storm drainage facility without causing damage to public or private property.

Catch Basin. A chamber usually built at the curb line of a street for the admission of surface water to a storm drain or subdrain, having at its base a sediment sump designed to retain grit and detritus below the point of overflow.

Certified Professionals. Individuals who are trained and experienced in the principles of stormwater management, including erosion and sediment control as is demonstrated by completion of state registration, or professional certification that enable the individual to make judgments regarding stormwater management, treatment, and design.

Centerline of Channel. The thalweg of a channel.

Channel Improvement. Alteration, maintenance, or reconstruction of the channel area for the purpose of improving the channel capacity or overall drainage efficiency. The noted "improvement" does not necessarily imply water quality or habitat improvement within the channel or its adjacent area.

Channel Modification. Alteration of a channel by changing the physical dimensions or materials of its bed or banks. Channel modification includes damming, rip-rapping or other armoring, widening, deepening, straightening, relocating, lining, and significant removal of bottom or woody vegetation. Channel modification does not include the clearing of dead or dying vegetation, debris, or trash from the channel. Channelization is a severe form of channel modification typically involving relocation of the existing channel (e.g., straightening).

Channel Stabilization. Protecting the sides and bed of a channel from erosion by controlling flow velocities and flow directions using jetties, drops, or other structures and/or by fining the channel with vegetation, riprap, concrete, or other suitable lining material.

Channel. A portion of a natural or artificial watercourse which periodically or continuously contains moving water, or which forms a connecting link between two bodies of water. It has a defined bed and banks which serve to confine the water.

Class V injection well. A type of well, which typically has a depth greater than its largest surface dimension, emplaces fluids into the subsurface, and does not meet the definitions of Class I through Class IV wells as defined under 40 CFR 146.5. While the term includes the specific examples described in 40 CFR 144.81, septic systems that serve more than one (1) single-family dwelling or provide service for non-domestic waste, dug wells, bored wells, improved sinkholes, french drains, infiltration sumps, and infiltration galleries, it does not include surface impoundments, trenches, or ditches that are wider than they are deep.

Closed Conduit. A pipe, tube, or tile used for transmitting water.

Combined Sewer Overflow. A system designed and used to receive and transport combined sewage so that during dry periods the wastewater is carried to a treatment facility. During storm events, the excess water is discharged directly into a river, stream, or lake without treatment.

Compensatory Storage. An artificial volume of storage within a floodplain used to balance the loss of natural flood storage capacity when artificial fill or substructures are placed within the floodplain.

Compost. Organic residue (or a mixture of organic residue and soil) that has undergone biological decomposition until it has become relatively stable humus.

Comprehensive Stormwater Management Program. A comprehensive stormwater program for effective management of stormwater quantity and quality throughout the community.

Constructed Wetland. A manmade shallow pool that creates growing conditions suitable for wetland vegetation and is designed to maximize pollutant removal.

Construction activity. Land disturbing activities, and land disturbing activities associated with the construction of infrastructure and structures. This term does not include routine ditch or road maintenance or minor landscaping projects.

Construction plan. A representation of a project site and all activities associated with the project. The plan includes the location of the project site, buildings and other infrastructure, grading activities, schedules for implementation and other pertinent information related to the project site. A storm water pollution prevention plan is a part of the construction plan.

Construction site access. A stabilized stone surface at all points of ingress or egress to a project site, for the purpose of capturing and detaining sediment carried by tires of vehicles or other equipment entering or exiting the project site.

Construction Support Activities. Include but are not limited to the following: concrete or asphalt batch plants, equipment staging yards, material storage areas, excavated material disposal areas, borrow areas. Such activities must not support multiple, unrelated projects, be a commercial/industrial operation, or continue to operate beyond the completion of the construction activity for the project it supports.

Contiguous. Adjoining or in actual contact with.

Contour Line. Line on a map which represents a contour or points of equal elevation.

Contour. An imaginary line on the surface of the earth connecting points of the same elevation.

Contractor or subcontractor. An individual or company hired by the project site or individual lot owner, their agent, or the individual lot operator to perform services on the project site.

Control Structure. A structure designed to control the rate of flow that passes through the structure, given a specific upstream and downstream water surface elevation.

Conveyance. Any structural method for transferring stormwater between at least two points. The term includes piping, ditches, swales, curbs, gutters, catch basins, channels, storm drains, and roadways.

Convolution. The process of translating precipitation excess into a runoff hydrograph.

Crawl Space. Low space below first floor of a house where there has not been excavation deep enough for a basement, usually less than seven (7) feet in depth, but where there is access for pipes, ducts, utilities and similar equipment.

Critical Duration Analysis. The process of testing different rainfall durations to find that "critical duration", which produces the highest peak runoff or the highest storage volume.

Cross-Section. A graph or plot of ground elevation across a stream valley or a portion of it, usually along a line perpendicular to the stream or direction of flow.

Crown of Pipe. The elevation of top of pipe.

Cubic Feet Per Second (CFS). Used to describe the amount of flow passing a given point in a stream channel. One cubic foot per second is equivalent to approximately 7.5 gallons per second.

Culvert. A closed conduit used for the conveyance of surface drainage water under a roadway, railroad, canal or other impediment.

Curve Number (CN). The Soil Conservation Service index that represents the combined hydrologic effect of soil, land use, land cover, hydrologic condition and antecedent runoff condition.

Dam. A barrier to confine or impound water for storage or diversion, to prevent gully erosion, or to retain soil, sediment, or other debris.

Damage. Measurable rise in flood heights on buildings currently subject to flooding, flooding of buildings currently not subject to flooding and increases in volume or velocity to the point where the rate of land lost to erosion and scour is substantially increased.

Datum. Any level surface to which elevations are referred, usually Mean Sea Level.

Dechlorinated swimming pool discharge. Chlorinated water that has either sat idle for seven (7) days following chlorination prior to discharge to the MS4 conveyance, or, by analysis, does not contain detectable concentrations (less than five-hundredths (0.05) milligram per liter) of chlorinated residual.

Depressional Storage Areas. Non-riverine depressions in the earth where stormwater collects. The volumes are often referred to in units of acre-feet.

Design Storm. A selected storm event, described in terms of the probability of occurring once within a given number of years, for which drainage or flood control improvements are designed and built.

Detention Basin. A facility constructed or modified to restrict the flow of storm water to a prescribed maximum rate, and to detain concurrently the excess waters that accumulate behind the outlet.

Detention Facility. A facility designed to detain a specified amount of stormwater runoff assuming a specified release rate. The volumes are often referred to in units of acre-feet.

Detention Storage. The temporary detaining of storage of stormwater in storage facilities, on rooftops, in streets, parking lots, school yards, parks, open spaces or other areas under predetermined and controlled conditions, with the rate of release regulated by appropriately installed devices.

Detention Time. The theoretical time required to displace the contents of a tank or unit at a given rate of discharge (volume divided by rate of discharge).

Detention. Managing stormwater runoff by temporary holding and controlled release.

Detritus. Dead or decaying organic matter; generally contributed to stormwater as fallen leaves and sticks or as dead aquatic organisms.

Developer. Any person financially responsible for construction activity, or an owner of property who sells or leases, or offers for sale or lease, any lots in a subdivision.

Development. Any man-made change to improved or unimproved real estate including but not limited to:

1. Construction, reconstruction, or placement of a building or any addition to a building;
2. Construction of flood control structures such as levees, dikes, dams or channel improvements;
3. Construction or reconstruction of bridges or culverts;
4. Installing a manufactured home on a site, preparing a site for a manufactured home, or installing a recreational vehicle on a site for more than hundred eight (180) days;
5. Installing utilities, erection of walls, construction of roads, or similar projects;
6. Mining, dredging, filling, grading, excavation, or drilling operations;
7. Storage of materials; or
8. Any other activity that might change the direction, height, or velocity of flood or surface waters.

“Development” does not include activities such as the maintenance of existing buildings and facilities such as painting, re-roofing, resurfacing roads, or gardening, plowing and similar agricultural practices that do not involve filling, grading, excavation, or the construction of permanent buildings.

Direct Release. A method of stormwater management where runoff from a part or the entire development is released directly to the receiving stream without providing detention.

Discharge. Usually the rate of water flow. A volume of fluid passing a point per unit time commonly expressed as cubic feet per second, cubic meters per second, gallons per minute, or millions of gallons per day.

Disposal. The discharge, deposit, injection, spilling, leaking, or placing of any solid waste or hazardous waste into or on any land/or water so that the solid waste or hazardous waste, or any constituent of the waste, may enter the environment, be emitted into the air, or be discharged into any waters, including

Ditch. A man-made, open drainageway in or into which excess surface water or groundwater drained from land, stormwater runoff, or floodwaters flow either continuously or intermittently.

Drain. A buried slotted or perforated pipe or other conduit (subsurface drain) or a ditch (open drain) for carrying off surplus groundwater or surface water.

Drainage Area. The area draining into a stream at a given point. It may be of different sizes for surface runoff, subsurface flow and base flow, but generally the surface runoff area is considered as the drainage area.

Drainage Classification (soil). As a natural condition of the soil, drainage refers to both the frequency and duration of periods when the soil is free of saturation. Soil drainage conditions are defined as:

- *Well-drained*--Excess water drains away rapidly, and no mottling occurs within 36 inches of the surface.
- *Moderately well drained*--Water is removed from the soil somewhat slowly resulting in small but significant periods of wetness, and mottling occurs between 18 and 36 inches.
- *Poorly drained*--Water is removed so slowly that it is wet for a large part of the time, and mottling occurs between 0 and 8 inches.

- *Somewhat poorly drained*--Water is removed from the soil slowly enough to keep it wet for significant periods but not all of the time, and mottling occurs between 8 to 18 inches. *Very poorly drained*--Water is removed so slowly that the water table remains at or near the surface for the greater part of the time; there may also be periods of surface ponding; the soil has a black to gray surface layer with mottles up to the surface.

Drainage. The removal of excess surface water or groundwater from land by means of ditches or subsurface drains. Also see Natural drainage.

Drop Manhole. Manhole having a vertical drop pipe connecting the inlet pipe to the outlet pipe. The vertical drop pipe shall be located immediately outside the manhole.

Dry Well. A type of infiltration practice that allows stormwater runoff to flow directly into the ground via a bored or otherwise excavated opening in the ground surface.

Dry-Bottom Detention Basin. A basin designed to be completely dewatered after having provided its planned detention of runoff during a storm event.

Duration. The time period of a rainfall event.

Earth Embankment. A man-made deposit of soil, rock, or other material often used to form an impoundment.

Elevation Certificate. A form published by the Federal Emergency Management Agency that is used to certify the 100-year or base flood elevation and the lowest elevation of usable space to which a building has been constructed.

Elevation Reference Mark (ERM). Elevation benchmark tied to the National Geodetic Vertical Datum of 1929 and identified during the preparation of a Flood Insurance Study prepared for the Federal Emergency Management Agency.

Emergency Spillway. Usually, a vegetated earth channel used to safely convey flood discharges around an impoundment structure.

Energy Dissipater. A device to reduce the energy of flowing water.

Environment. The sum total of all the external conditions that may act upon a living organism or community to influence its development or existence.

Erosion and sediment control measure. A practice, or a combination of practices, to control erosion and resulting sedimentation. and/or off-site damages.

Erosion and sediment control system. The use of appropriate erosion and sediment control measures to minimize sedimentation by first reducing or eliminating erosion at the source and then as necessary, trapping sediment to prevent it from being discharged from or within a project site.

Erosion control plan. A written description and site plan of pertinent information concerning erosion control measures designed to meet the requirements of the Ordinance or these Standards.

Erosion. The wearing away of the land surface by water, wind, ice, gravity, or other geological agents. The following terms are used to describe different types of water erosion:

- *Accelerated erosion* -- Erosion much more rapid than normal or geologic erosion, primarily as a result of the activities of man.
- *Channel erosion* -- An erosion process whereby the volume and velocity of flow wears away the bed and/or banks of a well-defined channel.
- *Gully erosion* --An erosion process whereby runoff water accumulates in narrow channels and, over relatively short periods, removes the soil to considerable depths, ranging from 1-2 ft. to as much as 75-100 ft.
- *Rill erosion*--An erosion process in which numerous small channels only several inches deep are formed; occurs mainly on recently disturbed and exposed soils (see Rill).

- **Splash erosion**--The spattering of small soil particles caused by the impact of raindrops on wet soils; the loosened and spattered particles may or may not be subsequently removed by surface runoff.
- **Sheet erosion**--The gradual removal of a fairly uniform layer of soil from the land surface by runoff water.

Extraterritorial Jurisdiction (ETJ). Areas located outside the corporate limits of a community over which the community has statutory development authority.

Farm or Field Tile. A pipe installed in an agricultural area to allow subsurface drainage of farmland for the purpose of agricultural production.

FEMA. The Federal Emergency Management Agency.

Filter Strip. Usually a long, relatively narrow area (usually, 20-75 feet wide) of undisturbed or planted vegetation used near disturbed or impervious surfaces to filter stormwater pollutants for the protection of watercourses, reservoirs, or adjacent properties.

Final stabilization. The establishment of permanent vegetative cover or the application of a permanent non-erosive material to areas where all land disturbing activities have been completed and no additional land disturbing activities are planned under the current permit.

Floatable. Any solid waste that will float on the surface of the water.

Flood (or Flood Waters). A general and temporary condition of partial or complete inundation of normally dry land areas from the overflow, the unusual and rapid accumulation, or the runoff of surface waters from any source.

Flood Boundary and Floodway Map (FBFM). A map prepared by the Federal Emergency Management Agency that depicts the FEMA designated floodways within a community. This map also includes delineation of the 100-year and 500-year floodplain boundaries and the location of the Flood Insurance Study cross-sections.

Flood Crest. The maximum stage or elevation reached or expected to be reached by the waters of a specific flood at a given time.

Flood Duration. The length of time a stream is above flood stage or overflowing its banks.

Flood Easement. Easement granted to identify areas inundated by the 100-year flood and prohibit or severely restrict development activities.

Flood Elevation. The elevation at all locations delineating the maximum level of high waters for a flood of given return period.

Flood Fighting. Actions taken immediately before or during a flood to protect human life and to reduce flood damages such as evacuation, emergency sandbagging and diking.

Flood Forecasting. The process of predicting the occurrence, magnitude and duration of an imminent flood through meteorological and hydrological observations and analysis.

Flood Frequency. A statistical expression of the average time period between floods equaling or exceeding a given magnitude. For example, a 100-year flood has a magnitude expected to be equaled or exceeded on the average of once every hundred years; such a flood has a one-percent chance of being equaled or exceeded in any given year. Often used interchangeably with "recurrence interval".

Flood Hazard Area. Any floodplain, floodway, floodway fringe, or any combination thereof which is subject to inundation by the regulatory flood; or any flood plain as delineated by Zone X on a Flood Hazard Boundary Map.

Flood Hazard Boundary Map (FHBM). A map prepared by the Federal Emergency Management Agency that depicts Special Flood Hazard Areas as a Zone A within a community. There are no study text, base flood elevations, or floodways associated with this map.

Flood Insurance Rate Map (FIRM). A map prepared by the Federal Emergency Management Agency that depicts Special Flood Hazard Areas within a community. This map also includes the 100-year or Base Flood Elevation at various locations

along the watercourses. More recent versions of the FIMR may also show the FEMA designated floodway boundaries and the location of the Flood Insurance Study cross-sections.

Flood Insurance Study (FIS). A study prepared by the Federal Emergency Management agency to assist a community participating in the National Flood Insurance Program in its application of the program regulations. The study consists of a text which contains community background information with respect to flooding, a floodway data table, summary of flood discharges, flood profiles, a Flood Insurance Rate Map, and a Flood Boundary and Floodway Map.

Flood Profile. A graph showing the relationship of water surface elevation to a specific location, the latter generally expressed as distance above the mouth of a stream of water flowing in a channel. It is generally drawn to show surface elevation for the crest or a specific magnitude of flooding, but may be prepared for conditions at any given time or stage.

Flood Protection Grade (FPG). The elevation of the regulatory or 100-year flood plus two (2) feet of freeboard if the flooding source is a lake, pond, stream, or an open channel/ditch (or 1 foot of freeboard if the flooding source is an overflow path/ponding area provided that the elevation of the overflow path/ponding area is calculated based on the assumption of fully plugged storm pipe system).

Flood Resistant Construction (Flood Proofing). Additions, changes or adjustments to structures or property that are designed to reduce or eliminate the potential for flood damage.

Flood Storage Areas. Depressions, basins, or other areas that normally stand empty or partially empty, but fill with rainfall runoff during storms to hold the runoff and reduce downstream flow rates. The volumes are often referred to in units or acre-feet.

Floodplain Management. The operation of a program of corrective and preventive measures for reducing flood damage, including but not limited to flood control projects, floodplain land use regulations, flood proofing of buildings, and emergency preparedness plans.

Floodplain Regulations. General term applied to the full range of codes, ordinances and other regulations relating to the use of land and construction within floodplain limits. The term encompasses zoning ordinances, subdivision regulations, building and housing codes, encroachment laws and open area (space) regulations.

Floodplain. The channel proper and the areas adjoining the channel which have been or hereafter may be covered by the regulatory or 100-year flood. Any normally dry land area that is susceptible to being inundated by water from any natural source. The floodplain includes both the floodway and the floodway fringe districts.

Floodway Fringe. That portion of the flood plain lying outside the floodway, which is inundated by the regulatory flood.

Floodway. The channel of a river or stream and those portions of the floodplains adjoining the channel which are reasonably required to efficiently carry and discharge the peak flow of the regulatory flood of any river or stream.

Fluvial Erosion Hazard (FEH) Corridor. Fluvial (riverine) Erosion Hazard corridors represent the areas along the streams (including the channel and immediate overbanks areas) that are believed to be subject to stream movement or streambank erosion. These corridors have been delineated for most actively migrating and relatively stationary streams in Indiana through an Indiana Silver Jackets initiative, with data for Clark County currently contained on the Clark County GIS website. More detailed mapping than that used as part of the Indiana Silver Jackets erosion hazard mapping program may be provided by the applicant if it is based on detailed field assessment acceptable to the CCDB or designee.

Remove if FEH requirements are not being included

Footing Drain. A drain pipe installed around the exterior of a basement wall foundation to relieve water pressure caused by high groundwater elevation.

Forebay (or Sediment Forebay). A small pond placed in front of a larger retention/detention structure such as a wet pond, dry pond, or wetland to intercept and concentrate a majority of sediment that is coming into the system before it reaches the larger structure.

Freeboard. An increment of height added to the base flood elevation to provide a factor of safety for uncertainties in calculations, unknown local conditions, wave actions and unpredictable effects such as those caused by ice or debris jams. (See Flood Protection Grade).

French Drain. A drainage trench backfilled with a coarse, water-transmitting material; may contain a perforated pipe.

Gabion. An erosion control structure consisting of a wire cage or cages filled with rocks.

Garbage. All putrescible animal solid, vegetable solid, and semisolid wastes resulting from the processing, handling, preparation, cooking, serving, or consumption of food or food materials.

Geographical Information System. A computer system capable of assembling, storing, manipulation, and displaying geographically referenced information. This technology can be used for resource management and development planning.

Geotextile Fabric. A woven or non-woven, water-permeable synthetic material used to trap sediment particles, prevent the clogging of aggregates with fine grained soil particles, or as a separator under road aggregate.

Geotextile Liner. A synthetic, impermeable fabric used to seal impoundments against leaks.

Global Positioning System. A system that provides specially coded satellite signals that is processed by a receiver, which determines position, velocity, and time. The system is funded and controlled by the U.S. Department of Defense.

Grade. (1) The inclination or slope of a channel, canal, conduit, etc., or natural ground surface usually expressed in terms of the percentage the vertical rise (or fall) bears to the corresponding horizontal distance. (2) The finished surface of a canal bed, roadbed, top of embankment, or bottom of excavation; any surface prepared to a design elevation for the support of construction, such as paving or the laying of a conduit. (3) To finish the surface of a canal bed, roadbed, top of embankment, or bottom of excavation, or other land area to a smooth, even condition.

Grading. The cutting and filling of the land surface to a desired slope or elevation.

Grass. A member of the botanical family Graminae, characterized by blade-like leaves that originate as a sheath wrapped around the stem.

Grassed swale. A type of vegetative practice used to filter stormwater runoff via a vegetated, shallow-channel conveyance.

Grassed Waterway. A natural or constructed waterway, usually broad and shallow, covered with erosion-resistant grasses and used to conduct surface water from an area.

Ground Cover (horticulture). Low-growing, spreading plants useful for low-maintenance landscape areas.

Groundwater Recharge. The infiltration of water into the earth. It may increase the total amount of water stored underground or only replenish supplies depleted through pumping or natural discharge.

Groundwater. Accumulation of underground water, natural or artificial. The term does not include

Habitat. The environment in which the life needs of a plant or animal are supplied.

Hard Surface. See "Impervious Surface."

High Water. Maximum designed permitted, or regulated water level for an impoundment.

Household Hazardous Waste. Solid waste generated by households that is ignitable, toxic, reactive, corrosive, or otherwise poses a threat to human health or the environment.

Hydraulic Grade Line (HGL). For Channel flow, the HGL is equal to the water surface whereas for pressure flow it is the piezometric surface.

Hydraulics. A branch of science that deals with the practical application of the mechanics of water movement. A typical hydraulic study is undertaken to calculate water surface elevations.

Hydrodynamic Loads. Forces imposed on structures by floodwaters due to the impact of moving water on the upstream side of the structure, drag along its sides, and eddies or negative pressures on its downstream side.

Hydrograph. For a given point on a stream, drainage basin, or a lake, a graph showing either the discharge, stage (depth), velocity, or volume of water with respect to time.

Hydrologic Unit Code. A numeric United States Geologic Survey code that corresponds to a watershed area. Each area also has a text description associated with the numeric code.

Hydrology. The science of the behavior of water in the atmosphere, on the surface of the earth, and underground. A typical hydrologic study is undertaken to compute flow rates associated with specified flood events.

Hydrometeorologic. Water-related meteorological data such as rainfall or runoff.

Hydrostatic Loads. Those loads or pressures resulting from the static mass of water at any point of floodwater contact with a structure. They are equal in all direction and always act perpendicular to the surface on which they are applied. Hydrostatic loads can act vertically on structural members such as floors, decks and roofs, and can act laterally on upright structural members such as walls, piers, and foundations.

IDNR. Indiana Department of Natural Resources.

Illicit Discharge. Any discharge to a conveyance that is not composed entirely of stormwater except naturally occurring floatables, such as leaves or tree limbs.

Impact Areas. Areas defined or mapped that are unlikely to be easily drained because of one or more factors including but not limited to any of the following: soil type, topography, land where there is not adequate outlet, a floodway or floodplain, FEH corridor, or land within 50 feet of each bank of a natural waterway.

Impaired Waters. Waters that do not or are not expected to meet applicable water quality standards, as included on IDEM's CWA Section 303(d) List of Impaired Waters.

Impervious surface. Surfaces, such as pavement and rooftops, which prevent the infiltration of stormwater into the soil.

Individual building lot. A single parcel of land within a multi-parcel development.

Individual lot operator. A contractor or subcontractor working on an individual lot.

Individual lot owner. A person who has financial control of construction activities for an individual lot.

INDOT. Indiana Department of Transportation. Generally used here to refer to specifications contained in the publication "INDOT Standard Specifications."

Infiltration practices. Any structural BMP designed to facilitate the percolation of run-off through the soil to ground water. Examples include infiltration basins or trenches, dry wells, and porous pavement.

Infiltration. Passage or movement of water into the soil.

Infiltration Swales. A depressed earthen area that is designed to promote infiltration.

Inlet. An opening into a storm drain system for the entrance of surface storm water runoff, more completely described as a storm drain inlet.

Intermittent Stream. A stream which carries water a considerable portion of the time, but which ceases to flow occasionally or seasonally because bed seepage and evapotranspiration exceed the available water supply.

Invert. The inside bottom of a culvert or other conduit.

Junction Chamber. A converging section of conduit, usually large enough for a person to enter, used to facilitate the flow from one or more conduits into a main conduit.

Land Surveyor. A person licensed under the laws of the State of Indiana to practice land surveying.

Land-disturbing Activity. Any man-made change of the land surface, including removing vegetative cover that exposes the underlying soil, excavating, filling, transporting and grading.

Larger common plan of development or sale. A plan, undertaken by a single project site owner or a group of project site owners acting in concert, to offer lots for sale or lease; where such land is contiguous, or is known, designated, purchased

or advertised as a common unit or by a common name, such land shall be presumed as being offered for sale or lease as part of a larger common plan. The term also includes phased or other construction activity by a single entity for its own use.

Lateral Storm Sewer. A drain that has inlets connected to it but has no other storm drain connected.

Life Cycle Cost. Cost based on the total cost incurred over the system life including research, development, testing, production, construction, operation, and maintenance. Costs are normally determined on present worth or equivalent annual cost basis.

Low Entry Elevation. The elevation in a structure where overbank flooding can enter the structure.

Lowest Adjacent Grade. The elevation of the lowest grade adjacent to a structure, where the soil meets the foundation around the outside of the structure (including structural members such as basement walkout, patios, decks, porches, support posts or piers, and rim of the window well).

Lowest Floor. Refers to the lowest of the following:

1. The top of the basement floor;
2. The top of the garage floor, if the garage is the lowest level of the building;
3. The top of the first floor of buildings constructed on a slab or of buildings elevated on pilings or constructed on a crawl space with permanent openings; or
4. The top of the floor level of any enclosure below an elevated building where the walls of the enclosure provide any resistance to the flow of flood waters unless:
 - a] The walls are designed to automatically equalize the hydrostatic flood forces on the walls by allowing for the entry and exit of flood waters, by providing a minimum of two opening (in addition to doorways and windows) having a total area of one (1) square foot for every two (2) square feet of enclosed area subject to flooding. The bottom of all such openings shall be no higher than one (1) foot above grade.
 - b] Such enclosed space shall be usable only for the parking of vehicles or building access.

Low Impact Development. LID is a land planning and engineering design approach with a goal of replicating the pre-development hydrologic regime of urban and developing watersheds. The primary goal of LID is to mimic a site's predevelopment hydrology by reducing the impervious surface, infiltrating, filtering, storing, evaporating, and detaining runoff close to its source.

Major Drainage System. Drainage system carrying runoff from an area of one or more square miles.

Manhole. Storm drain structure through which a person may enter to gain access to an underground storm drain or enclosed structure.

Manning Roughness Coefficient or Manning's "n" Value. A dimensionless coefficient ("n") used in the Manning's equation to account for channel wall frictional losses in steady uniform flow.

Measurable storm event. A precipitation event that results in a total measured precipitation accumulation equal to, or greater than, one-half (0.5) inch of rainfall.

Minimum Control Measure. Minimum measures required by the NPDES Phase II program. The six (6) MCMs are: Public education and outreach, Public participation and involvement, Illicit discharge detection and elimination, Construction site runoff control, Post-construction runoff control, and Pollution prevention and good housekeeping.

Minor Drainage Systems. Drainage system carrying runoff from an area of less than one square mile.

Minor Subdivision. See Subdivision, Minor.

Mulch. A natural or artificial layer of plant residue or other materials covering the land surface which conserves moisture, holds soil in place, aids in establishing plant cover, and minimizes temperature fluctuations.

Multi-Family. Any structure which contains three or more dwelling units. A dwelling unit is any structure, or part of a structure, which is constructed to a house a family.

Municipal Separate Storm Sewers. An MS4 meets all the following criteria: (1) is a conveyance or system of conveyances owned by the state, county, City, or other public entity; (2) discharges to waters of the U.S.; (3) is designed or used for collecting or conveying stormwater; (4) is not a combined sewer; and, (5) is not part of a Publicly Owned Treatment Works (POTW).

Municipal, state, federal, or institutional refueling area. An operating gasoline or diesel fueling area whose primary function is to provide fuel to either municipal, state, federal, or institutional equipment or vehicles.

Mutual Drain. A drain that: (1) is located on two or more tracts of land that are under different ownership; (2) was established by the mutual consent of all the owners; and (3) was not established under or made subject to any drainage statute.

National Flood Insurance Program (NFIP). The NFIP is a federal program enabling property owners to purchase flood insurance. The Federal Emergency Management Agency administers the NFIP in communities throughout the United States. The NFIP is based on an agreement between local communities and the Federal government which states that if a community will implement floodplain management measures to reduce future flood risks to new construction and substantially improved structures in flood hazard areas, the Federal government will make flood insurance available within the community as a financial protection against flood losses that do occur.

National Geodetic Vertical Datum of 1929. The nationwide, Federal Elevation datum used to reference topographic elevations to a known value.

National Pollution Discharge Elimination System (NPDES). A permit developed by the U.S. EPA through the Clean Water Act. In Indiana, the permitting process has been delegated to IDEM. This permit covers aspects of municipal stormwater quality.

Natural Drainage. The flow patterns of stormwater run-off over the land in its pre-development state.

Nonagricultural land use. Commercial use of land for the manufacturing and wholesale or retail sale of goods or services, residential or institutional use of land intended primarily to shelter people, highway use of land including lanes, alleys, and streets, and other land uses not included in agricultural land use.

Nonpoint Source Pollution. Pollution that enters a water body from diffuse origins on the watershed and does not result from discernable, confined, or discrete conveyances.

Normal Depth. Depth of flow in an open conduit during uniform flow for the given conditions.

North American Vertical Datum of 1988 (NAVD 1988). The nationwide, Federal Elevation datum used to reference topographic elevations to a known value.

Nutrient(s). (1) A substance necessary for the growth and reproduction of organisms. (2) In water, those substances (chiefly nitrates and phosphates) that promote growth of algae and bacteria.

Off-site. Everything not located at or within a particular site.

Off-site Land Areas. Those areas that by virtue of existing topography naturally shed surface water onto or through the developing property.

100-Year Frequency Flood. See "regulatory flood".

On-Site. Located within the controlled or urbanized area where runoff originates.

Open Drain. A natural watercourse or constructed open channel that conveys drainage water.

Open Space. Any land area devoid of any disturbed or impervious surfaces created by industrial, commercial, residential, agricultural, or other manmade activities.

Orifice. A device which controls the rate of flow from a detention basin.

Outfall scouring. The deterioration of a streambed or lakebed from an outfall discharge to an extent that the excessive settling of solid material results and suitable aquatic habitat is diminished.

Outfall. The point, location, or structure where a pipe or open drain discharges to a receiving body of water.

Outlet. The point of water disposal from a stream, river, lake, tidewater, or artificial drain.

Overland Flow. Consists of sheet flow, shallow concentrated flow and channel flow.

Peak Discharge (or Peak Flow). The maximum instantaneous flow from a given storm condition at a specific location.

Percolation. The movement of water through soil.

Perennial Stream. A stream that maintains water in its channel throughout the year.

Permanent stabilization. The establishment, at a uniform density of seventy percent (70%) across the disturbed area, of vegetative cover or permanent non-erosive material that will ensure the resistance of the soil to erosion, sliding, or other movement.

Permeability (soil). The quality of a soil that enables water or air to move through it. Usually expressed in inches per hour or inches per day.

Pervious. Allowing movement of water.

Pesticides. Chemical compounds used for the control of undesirable plants, animals, or insects. The term includes insecticides, herbicides, algicides, rodenticides, nematocides, fungicides, and growth regulators.

pH. A numerical measure of hydrogen ion activity, the neutral point being 7.0. All pH values below 7.0 are acid, and all above 7.0 are alkaline.

Phasing of construction. Sequential development of smaller portions of a large project site, stabilizing each portion before beginning land disturbance on subsequent portions, to minimize exposure of disturbed land to erosion.

Phosphorus (available). Inorganic phosphorus that is readily available for plant growth.

Piping. The formation of "pipes" by underground erosion. Water in the soil carries the fine soil particles away, and a series of eroded tubes or tunnels develop. These openings will grow progressively larger and can cause a dam failure.

Planimetric Data. Horizontal measurements involving distances or dimensions on a diagram, map, Plat of Survey or topographic map. Normally in units of feet.

Plat of Survey. A scaled diagram showing boundaries of a tract of land/or subdivision. This may constitute a legal description of the land and be used in lieu of a written description.

Point Source. Any discernible, confined, and discrete conveyance including but not limited to any pipe, ditch, channel, tunnel, conduit, well, discrete fissure, or container from which pollutants are or maybe discharged (P.L. 92-500, Section 502[14]).

Pollutant of concern. Any pollutant that has been documented via analytical data as a cause of impairment in any waterbody.

Porosity. The volume of pore space in soil or rock.

Porous pavement. A type of infiltration practice to improve the quality and reduce the quantity of storm water run-off via the use of manmade, pervious pavement which allows run-off to percolate through the pavement and into underlying soils

Private Drain. A drain that: (1) Is located on land owned by one person or by two or more persons jointly; and (2) was not established under or made subject to any drainage statute.

Professional Engineer. A person licensed under the laws of the State of Indiana to practice professional engineering.

Programmatic Indicator. Any data collected by an MS4 entity that is used to indicate implementation of one (1) or more minimum control measures.

Project site owner. The person required to submit a stormwater permit application and required to comply with the terms of the ordinance or these Technical Standards, including a developer or a person who has financial and operational control of construction activities, and project plans and specifications, including the ability to make modifications to those plans and specifications.

Project site. The entire area on which construction activity is to be performed.

Probable Maximum Flood. The most severe flood that may be expected from a combination of the most critical meteorological and hydrological conditions that are reasonably possible in the drainage basin. It is used in designing high-risk flood protection works and citing of structures and facilities that shall be subject to almost no risk of flooding. The probable maximum flood is usually much larger than the 100-year flood.

Publicly Owned Treatment Works (POTW). A municipal operation that breaks down and removes contaminants in the wastewater prior to discharging to a stream through primary and/or secondary treatment systems.

Qualified professional. An individual who is trained and experienced in storm water treatment techniques and related fields as may be demonstrated by state registration, professional certification, experience, or completion of coursework that enable the individual to make sound, professional judgments regarding storm water control or treatment and monitoring, pollutant fate and transport, and drainage planning.

Radius of Curvature. Length of radius of a circle used to define a curve.

Rain garden. A vegetative practice used to alter impervious surfaces, such as roofs, into pervious surfaces for absorption and treatment of rainfall.

Rainfall Intensity. The rate at which rain is falling at any given instant, usually expressed in inches per hour.

Reach. Any length of river, channel or storm drain.

Receiving Stream or Receiving Water. The body of water into which runoff or effluent is discharged. The term does not include private drains, unnamed conveyances, retention and detention basins, or constructed wetlands used as treatment.

Recharge. Replenishment of groundwater reservoirs by infiltration and transmission from the outcrop of an aquifer or from permeable soils.

Recurrence Interval. A statistical expression of the average time between floods equaling or exceeding a given magnitude.

Redevelopment. Alterations of a property that change a site or building in such a way that there is disturbances of one (1) acre or more of land. The term does not include such activities as exterior remodeling.

Regional Pond. A detention/retention basin sized to detain/retain the runoff from the entire watershed, on-site and off-site, tributary to the pond's outlet.

Regulated Area. The following areas within Clark County:

1. All territory of the County except for a territory of a municipality located within the County unless the municipality has entered into an agreement to adopt the Clark County Stormwater Management Ordinance.

Regulated Drain. A drain subject to the provisions of the Indiana Drainage Code, I.C.-36-9-27.

Regulatory or 100-Year Flood. The discharge or elevation associated with the 100-year flood as calculated by a method and procedure which is acceptable to and approved by the Indiana Department of Natural Resources and the Federal Emergency Management Agency. The "regulatory flood" is also known as the "base flood".

Regulatory Floodway. See Floodway.

Release Rate - The amount of storm water release from a storm water control facility per unit of time.

Reservoir. A natural or artificially created pond, lake or other space used for storage, regulation or control of water. May be either permanent or temporary. The term is also used in the hydrologic modeling of storage facilities.

Retail gasoline outlet. An operating gasoline or diesel fueling facility whose primary function is the resale of fuels. The term applies to facilities that create five thousand (5,000) or more square feet of impervious surfaces, or generate an average daily traffic count of one hundred (100) vehicles per one thousand (1,000) square feet of land area.

Retention basin. A type of storage practice, that has no positive outlet, used to retain storm water run-off for an indefinite amount of time. Runoff from this type of basin is removed only by infiltration through a porous bottom or by evaporation.

Retention. The storage of stormwater to prevent it from leaving the development site. May be temporary or permanent.

Retention Facility. A facility designed to completely retain a specified amount of stormwater runoff without release except by means of evaporation, infiltration or pumping. The volumes are often referred to in units of acre-feet.

Return Period - The average interval of time within which a given rainfall event will be equaled or exceeded once. A flood having a return period of 100 years has a one percent probability of being equaled or exceeded in any one year.

Revetment. Facing of stone or other material, either permanent or temporary, placed along the edge of a stream to stabilize the bank and protect it from the erosive action of the stream. Also see Revetment riprap.

Right-of-Way for a County Drain. The statutory right of way as defined by Indiana Code for a regulated drain.

Riparian habitat. A land area adjacent to a waterbody that supports animal and plant life associated with that waterbody.

Riparian zone. Of, on, or pertaining to the banks of a stream, river, or pond.

Riprap. Broken rock, cobble, or boulders placed on earth surfaces, such as the face of a dam or the bank of a stream, for protection against the action of water (waves). Revetment riprap is material graded such that: (1) no individual piece weighs more than 120 lbs. and (2) 90-100% will pass through a 12-inch sieve, 20-60% through a 6-inch sieve, and not more than 10% through a 12-inch sieve.

River Restoration. Restoring the channel of a stream or ditch to its perceived original, non-obstructed capacity by means of clearing & snagging, obstruction removal, and inexpensive streambank protection measures. The term "restoration", as noted, does not necessarily imply restoration or improvement of water quality or habitat within the channel or its adjacent area.

Riverine. Relating to, formed by, or resembling a stream (including creeks and rivers).

Runoff Coefficient - A decimal fraction relating the amount of rain which appears as runoff and reaches the storm drain system to the total amount of rain falling. A coefficient of 0.5 implies that 50 percent of the rain falling on a given surface appears as storm water runoff.

Runoff. That portion of precipitation that flows from a drainage area on the land surface, in open channels, or in stormwater conveyance systems.

Sand. (1) Soil particles between 0.05 and 2.0 mm in diameter. (2) A soil textural class inclusive of all soils that are at least 70% sand and 15% or less clay.

Sanitary Backup. The condition where a sanitary sewer reaches capacity and surcharges into the lowest area.

Scour. The clearing and digging action of flowing water.

Sediment. Solid material (both mineral and organic) that is in suspension, is being transported, or has been moved from its site of origin by air, water, gravity, or ice and has come to rest on the earth's surface.

Sediment Forebay. See "Forebay".

Sedimentation. The process that deposits soils, debris and other unconsolidated materials either on the ground surfaces or in bodies of water or watercourses.

Seepage. The passage of water or other fluid through a porous medium, such as the passage of water through an earth embankment or masonry wall.

Sensitive Water. A water body in need of priority protection or remediation based on its:

providing habitat for threatened or endangered species,

usage as a public water supply intake,

relevant community value,

usage for full body contact recreation,

exceptional use classification as found in 327 IAC 2-1-11(b), outstanding state resource water classification as found in 327 IAC 2-1-2(3) and 327 IAC 2-1.5-19(b).

Settling Basin. An enlargement in the channel of a stream to permit the settling of debris carried in suspension.

Silt Fence. A fence constructed of wood or steel supports and either natural (e.g. burlap) or synthetic fabric stretched across area of non-concentrated flow during site development to trap and retain on-site sediment due to rainfall runoff.

Silt. (1) Soil fraction consisting of particles between 0.002 and 0.05 mm in diameter. (2) A soil textural class indicating more than 80% silt.

Siphon - A closed conduit or portion of which lies above the hydraulic grade line, resulting in a pressure less than atmospheric and requiring a vacuum within the conduit to start flow. A siphon utilizes atmospheric pressure to effect or increase the flow of water through a conduit. An inverted siphon is used to carry storm water flow under an obstruction such as a sanitary sewer.

Site. The entire area included in the legal description of the land on which land disturbing activity is to be performed.

Silvicultural. the practice of controlling the establishment, growth, composition, health, and quality of forests to meet diverse needs and values.

1. Nonpoint activities include source silvicultural activities such as nursery operations, site preparation, reforestation and subsequent cultural treatment, thinning, prescribed burning, pest and fire control, harvesting operations, surface drainage, or road construction and maintenance from which there is natural runoff. Some of these activities (such as stream crossing for roads) may involve the placement of dredged or fill material which may require a CWA section 404 permit and a 401 Water Quality Certification.
2. Point source activities include any discernible, confined and discrete conveyance related to rock crushing, gravel washing, log sorting, or log storage facilities which are operated in connection with silvicultural activities and from which pollutants are discharged into waters of the United States or the State.

Slope. Degree of deviation of a surface from the horizontal, measured as a numerical ratio or percent. Expressed as a ratio, the first number is commonly the horizontal distance (run) and the second is the vertical distance (rise)—e.g., 2:1. However, the preferred method for designation of slopes is to clearly identify the horizontal (H) and vertical (V) components (length (L) and Width (W) components for horizontal angles). Also note that according to international standards (Metric), the slopes are presented as the vertical or width component shown on the numerator—e.g., 1V:2H. Slope expressions in the Ordinance or these Technical Standards follow the common presentation of slopes—e.g., 2:1 with the metric presentation shown in parenthesis—e.g., (1V:2H). Slopes can also be expressed in "percent". Slopes given in percent are always expressed as $(100 \cdot V/H)$ —e.g., a 2:1 (1V:2H) slope is a 50% slope.

Soil and Water Conservation District. A public organization created under state law as a special-purpose district to develop and carry out a program of soil, water, and related resource conservation, use, and development within its boundaries. A subdivision of state government with a local governing body, established under IC 14-32.

Soil. The unconsolidated mineral and organic material on the immediate surface of the earth that serves as a natural medium for the growth of land plants.

Solid Waste. Any garbage, refuse, debris, or other discarded material.

Special Flood Hazard Area. An area that is inundated during the 100-Year flood.

Spill. The unexpected, unintended, abnormal, or unapproved dumping, leakage, drainage, seepage, discharge, or other loss of petroleum, hazardous substances, extremely hazardous substances, or objectionable substances. The term does not include releases to impervious surfaces when the substance does not migrate off the surface or penetrate the surface and enter the soil.

Spillway - A waterway in or about a hydraulic structure, for the escape of excess water.

Standard Project Flood. A term used by the U.S. Army Corps of Engineers to designate a flood that may be expected from the most severe combination of meteorological and hydrological conditions that are considered reasonable characteristics of the geographical area in which the drainage basin is located, excluding extremely rare combinations. The peak flow for a standard project flood is generally 40 – 60 percent of the probable maximum flood for the same location.

Stilling Basin - A basin used to slow water down or dissipate its energy.

Storage practices. Any structural BMP intended to store or detain stormwater and slowly release it to receiving waters or drainage systems. The term includes detention and retention basins.

Storm drain signing. Any marking procedure that identifies a storm sewer inlet as draining directly to a receiving waterbody so as to avoid dumping pollutants. The procedures can include painted or cast messages and adhesive decals.

Storm Duration. The length of time that water may be stored in any stormwater control facility, computed from the time water first begins to be stored.

Storm Event. An estimate of the expected amount of precipitation within a given period of time. For example, a 10-yr. frequency, 24-hr. duration storm event is a storm that has a 10% probability of occurring in any one year. Precipitation is measured over a 24-hr. period.

Storm Frequency. The time interval between major storms of predetermined intensity and volumes of runoff--e.g., a 5-yr., 10-yr. or 20-yr. storm.

Storm Sewer. A closed conduit for conveying collected storm water, while excluding sewage and industrial wastes. Also called a storm drain.

Stormwater Drainage System - All means, natural or man-made, used for conducting storm water to, through or from a drainage area to any of the following: conduits and appurtenant features, canals, channels, ditches, storage facilities, swales, streams, culverts, streets and pumping stations.

Stormwater Facility. All ditches, channels, conduits, levees, ponds, natural and manmade impoundments, wetlands, tiles, swales, sewers and other natural or artificial means of draining surface and subsurface water from land.

Stormwater Pollution Prevention Plan. A plan developed to minimize the impact of storm water pollutants resulting from construction activities.

Stormwater Quality Management Plan. A comprehensive written document that addresses stormwater runoff quality.

Stormwater Quality Measure. A practice, or a combination of practices, to control or minimize pollutants associated with storm water runoff.

Stormwater runoff. The water derived from rains falling within a tributary basin, flowing over the surface of the ground or collected in channels or conduits.

Stormwater. Water resulting from rain, melting or melted snow, hail, or sleet.

Stream Gauging. The quantitative determination of streamflow using gauges, current meters, weirs, or other measuring instruments at selected locations (see Gauging station').

Stream Length. The length of a stream or ditch, expressed in miles, from the confluence of the stream or ditch with the receiving stream to the upstream extremity of the stream or ditch, as indicated by the solid or dashed, blue or purple line depicting the stream or ditch on the most current edition of the seven and one-half (72) minute topographic quadrangle map

published by the United States Geological Survey, measured along the meanders of the stream or ditch as depicted on the map.

Stream. See intermittent stream, Perennial stream, Receiving stream.

Streambanks. The usual boundaries (not the flood boundaries) of a stream channel. Right and left banks are named facing downstream.

Strip development. A multi-lot project where building lots front on an existing road.

Structure. Refers to a structure that is principally above ground and is enclosed by walls and a roof. The term includes but is not limited to, a gas or liquid storage tank, a manufactured home or a prefabricated building, and recreational vehicles to be installed on a site for more than 180 days.

Structural Engineer. A person licensed under the laws of the State of Indiana to engage in the designing or supervising of construction, enlargement or alteration of structures or any part thereof.

Structural Floodplain. Management Measures. Those physical or engineering measures employed to modify the way foods behave, (e.g., dams, dikes, levees, channel enlargements and diversions).

Subarea/Sub-basin. Portion of a watershed divided into homogenous drainage units which can be modeled for purposes of determining runoff rates. The subareas/sub-basins have distinct boundaries, as defined by the topography of the area.

Subdivision. Any land that is divided or proposed to be divided into lots, whether contiguous or subject to zoning requirements, for the purpose of sale or lease as part of a larger common plan of development or sale.

Subdivision, Minor. The subdivision of a parent parcel into any combination of not more than three (3) contiguous or non-contiguous new residential, commercial, or industrial building sites. The parcel shall front upon an existing street which is an improved right-of-way maintained by the County or other governmental entity and not involve any new street.

Subsoil. The B horizons of soils with distinct profiles. In soils with weak profile development, the subsoil can be defined as the soil below which roots do not normally grow.

Subsurface Drain. A pervious backfield trench, usually containing stone and perforated pipe, for intercepting groundwater or seepage.

Subwatershed. A watershed subdivision of unspecified size that forms a convenient natural unit. See also Subarea.

Sump Failure. A failure of the sump pump that results in inundation of crawl space or basement.

Sump Pump. A pump that discharges seepage from foundation footing drains.

Surcharge. Backup of water in a sanitary or storm sewer system in excess of the design capacity of the system.

Surface Runoff. Precipitation that flows onto the surfaces of roofs, streets, the ground, etc., and is not absorbed or retained by that surface but collects and runs off.

Suspended Solids. Solids either floating or suspended in water.

Swale. An elongated depression in the land surface that is at least seasonally wet, is usually heavily vegetated, and is normally without flowing water. Swales conduct stormwater into primary drainage channels and may provide some groundwater recharge.

Tailwater. The water surface elevation at the downstream side of a hydraulic structure (i.e. culvert, bridge, weir, dam, etc.).

Temporary Stabilization. The covering of soil to ensure its resistance to erosion, sliding, or other movement. The term includes vegetative cover, anchored mulch, or other non-erosive material applied at a uniform density of seventy percent (70%) across the disturbed area.

Thalweg. The deepest point (or centerline) of a channel.

Tile Drain. Pipe made of perforated plastic, burned clay, concrete, or similar material, laid to a designed grade and depth, to collect and carry excess water from the soil.

Tile Drainage. Land drainage by means of a series of tile lines laid at a specified depth, grade, and spacing.

Time of Concentration (tc). The travel time of a particle of water from the most hydraulically remote point in the contributing area to the point under study. This can be considered the sum of an overland flow time and times of travel in street gutters, storm sewers, drainage channels, and all other drainage ways.

Topographic Map. Graphical portrayal of the topographic features of a land area, showing both the horizontal distances between the features and their elevations above a given datum.

Topography. The representation of a portion of the earth's surface showing natural and man-made features of a give locality such as rivers, streams, ditches, lakes, roads, buildings and most importantly, variations in ground elevations for the terrain of the area.

Topsoil. (1) The dark-colored surface layer, or a horizon, of a soil; when present it ranges in depth from a fraction of an inch to 2-3 ft. (2) Equivalent to the plow layer of cultivated soils. (3) Commonly used to refer to the surface layer(s), enriched in organic matter and having textural and structural characteristics favorable for plant growth.

Total Maximum Daily Load. Method used to establish allowable loadings for specified pollutants in a surface water resource to meet established water quality standards.

Toxicity. The characteristic of being poisonous or harmful to plant or animal life. The relative degree or severity of this characteristic.

TP-40 Rainfall. Design storm rainfall depth data for various durations published by the National Weather Service in their Technical Paper 40 dated 1961.

Trained individual. An individual who is trained and experienced in the principles of storm water quality, including erosion and sediment control as may be demonstrated by state registration, professional certification (such as CESSWI and/or CPESC certification), or other documented and applicable experience or coursework as deemed sufficient by the CCDB or designee that enable the individual to make judgments regarding storm water control or treatment and monitoring.

Transition Section. Reaches of the stream of floodway where water flows from a narrow cross-section to a wide cross-section or vice-versa.

Tributary. Based on the size of the contributing drainage area, a smaller watercourse which flows into a larger watercourse.

Turbidity. (1) Cloudiness of a liquid, caused by suspended solids. (2) A measure of the suspended solids in a liquid.

Underdrain. A small diameter perforated pipe that allows the bottom of a detention basin, channel or swale to drain.

Unified Soil Classification System. A system of classifying soils that is based on their identification according to particle size, gradation, plasticity index, and liquid limit.

Uniform Flow. A state of steady flow when the mean velocity and cross-sectional area remain constant in all sections of a reach.

Unit Hydrograph. A unit hydrograph is the hydrograph that results from one inch of precipitation excess generated uniformly over the watershed at a uniform rate during a specified period of time.

Urban Drain. A drain defined as "Urban Drain" in Indiana Drainage Code.

Urbanization. The development, change or improvement of any parcel of land consisting of one or more lots for residential, commercial, industrial, institutional, recreational or public utility purposes.

Vegetative practices. Any nonstructural or structural BMP that, with optimal design and good soil conditions, utilizes various forms of vegetation to enhance pollutant removal, maintain and improve natural site hydrology, promote healthier habitats, and increase aesthetic appeal. Examples include grass swales, filter strips, buffer strips, constructed wetlands, and rain gardens.

Vegetative Stabilization. Protection of erodible or sediment producing areas with: permanent seeding (producing long-term vegetative cover), short-term seeding (producing temporary vegetative cover), or sodding (producing areas covered with a turf of perennial sod-forming grass).

Water Course. Any river, stream, creek, brook, branch, natural or man-made drainage way in or into which stormwater runoff or floodwaters flow either regularly or intermittently.

Water Quality. A term used to describe the chemical, physical, and biological characteristics of water, usually in respect to its suitability for a particular purpose.

Water Resources. The supply of groundwater and surface water in a given area.

Water Table. (1) The free surface of the groundwater. (2) That surface subject to atmospheric pressure under the ground, generally rising and falling with the season or from other conditions such as water withdrawal.

Waterbody. Any accumulation of water, surface, or underground, natural or artificial.

Watercourse. Any river, stream, creek, brook, branch, natural or man-made drainageway in or into which stormwater runoff or floodwaters flow either continuously or intermittently.

Watershed Area. All land and water within the confines of a drainage divide. See also Watershed.

Watershed. The region drained by or contributing water to a specific point that could be along a stream, lake or other stormwater facilities. Watersheds are often broken down into subareas for the purpose of hydrologic modeling.

Waterway. A naturally existing or manmade open conduit or channel utilized for the conveyance of water.

Weir. A channel-spanning structure for measuring or regulating the flow of water.

Wellhead protection area. Has the meaning set forth at 327 IAC 8-4.1-1(27).

Wet-Bottom Detention Basin (Retention Basin) - A basin designed to retain a permanent pool of water after having provided its planned detention of runoff during a storm event.

Wetlands. Areas that are inundated or saturated by surface water or groundwater at a frequency and duration sufficient to support, and that under normal circumstances do support, a prevalence of vegetation typically adapted for life in saturated soil conditions.

APPENDIX B

APPLICATIONS, FORMS AND MISCELLANEOUS SHEETS REQUIRED TO COMPLY WITH THE CLARK COUNTY STORMWATER MANAGEMENT ORDINANCE AND TECHNICAL STANDARDS

B1 – Stormwater Permit Forms

Application/Checklist for Stormwater Permit
Construction/SWPPP Technical Review Form
Petition to Clark County Drainage Board
Statement of Financial Responsibility
BMP Maintenance Agreement
Project Check-In Checklist

B2 – Construction Inspection/Completion Forms

Construction Self-Monitoring Report
Certification of Completion & Compliance
Termination Inspection Checklist

B3 – Individual Lot/Parcel Permit Forms

Instructions for Individual Lot Permit Request
Individual Lot Permit Request Application
Individual Lot Typical Erosion & Sediment Control Plan and Certification
Plot Plan Review Form
Individual Lot Stormwater Pollution Prevention Requirements

B1 –Stormwater Permit Forms

**Application/Checklist for Stormwater Permit
Construction/SWPPP Technical Review Form
Petition to Clark County Drainage Board
Statement of Financial Responsibility
BMP Maintenance Agreement
Project Check-In Checklist**

Clark County
Application/Checklist for Stormwater Permit
 (To Be Completed by Applicant)

Project Name:	
General Location:	
Form Completed By (Name):	Date Completed:
Total Site Acreage:	Proposed Land Disturbance Acreage:

1. Application Fee	
Check Attached	Amt. \$

2. Owner/Applicant Information		
Owner Name:	Phone #:	E-Mail:
Engineer Company Name:		
Engineer Name:	Phone #:	E-Mail:

Brief Project Purpose and Description:

3. Construction Plans – General Requirements	Page/Sheet #
---	---------------------

3.1	Title sheet which includes location map, vicinity map, operating authority, design company name, developer name, and index of plan sheets.	
3.2	A copy of a legal boundary survey for the site, performed in accordance with Rule 12 of Title 865 of the Indiana Administrative Code or any applicable and subsequently adopted rule or regulation for the subdivision limits, including all drainage easements and wetlands.	
3.3	A reduced plat or project site map showing the parcel identification numbers, the lot numbers, lot boundaries, easements, and road layout and names. The reduced map must be legible and submitted on a sheet or sheets no larger than eleven (11) inches by seventeen (17) inches for all phases or sections of the project site.	
3.4	An existing project site layout that must include the following information:	
3.4a	A topographic map of the land to be developed and such adjoining land whose topography may affect the layout or drainage of the development. The contour intervals shall be one (1) foot when slopes are less than or equal to two percent (<2%) and shall be two (2) feet when slopes exceed two percent (>2%). All elevations shall be given in either National Geodetic Vertical Datum of 1929 (NGVD) or North American Vertical Datum of 1988 (NAVD). The horizontal datum of topographic map shall be based on Indiana State Plane Coordinates, NAD83. The map will contain a notation indicating these datum information. <ul style="list-style-type: none"> i. If the project site is less than or equal to two (2) acres in total land area, the topographic map shall include all topography of land surrounding the site to a distance of at least one hundred (100) feet. ii. If the project site is greater than two (2) acres in total land area, the topographic map shall include all topography of land surrounding the site to a distance of at least two hundred (200) feet. 	
3.4b	Location, name, and normal water level of all wetlands, lakes, ponds, and water courses on or adjacent to the project site.	
3.4c	Location of storm, sanitary, combined sewer, and septic tank systems and outfalls.	
3.4d	The location of regulated drains, farm drains, inlets and outfalls, if any of record.	
3.4e	Location of all existing cornerstones within the proposed development and a plan to protect and preserve them.	

3.5	A grading and drainage plan, including the following information:		
3.5a	Location of all proposed site improvements, including roads, utilities, lot delineation and identification, proposed structures, and common areas.		
3.5b	Delineation of all proposed land disturbing activities, including off-site activities that will provide services to the project site.		
3.5c	Information regarding any off-site borrow, stockpile, or disposal areas that are associated with a project site, regardless of who owns or controls those areas. Off-site disposal areas may need to have their own permits.		
3.5d	Location, size, and dimensions of all existing streams to be maintained, and new drainage systems such as culverts, bridges, storm sewers, conveyance channels, and 100-year overflow paths/ponding areas shown as hatched areas, along with the associated easements.		
3.5e	Location, size, and dimensions of features such as permanent retention or detention facilities, including existing or manmade wetlands, used for the purpose of stormwater management. Include existing retention or detention facilities that will be maintained, enlarged, or otherwise altered and new ponds or basins to be built.		
3.5f	One or more typical cross sections of all existing and proposed channels or other open drainage facilities carried to a point above the 100-year high water and showing the elevation of the existing land and the proposed changes, together with the high water elevations expected from the 100 year storm under the controlled conditions called for by this ordinance, and the relationship of structures, streets, and other facilities.		
3.6	Utility plan sheet(s) showing the location of all proposed utility lines for the project		
3.7	Storm sewer plan/profile sheet(s) showing the elevation, size, length, location of all proposed storm sewers. Existing and proposed ground grades, storm sewer structures elevations, and utility crossings also must be included.		
3.8	A 24-inch by 36-inch plat, including the following information:		
3.8a	Legal description.		
3.8b	Cross reference to Rule 12.		
3.8c	Regulated drain statement and table, if any.		
3.9	Any other information required by CCDB or designee to thoroughly evaluate the submitted material.		
4. Storm Water Drainage Technical Report			Page/Sheet #
4.1	A summary report, including the following information:		
4.1a	Description of the nature and purpose of the project.		
4.1b	The significant drainage problems associated with the project.		
4.1c	The analysis procedure used to evaluate these problems and to propose solutions.		
4.1d	Any assumptions or special conditions associated with the use of these procedures, especially the hydrologic or hydraulic methods.		
4.1e	The proposed design of the drainage control system.		
4.1f	The results of the analysis of the proposed drainage control system showing that it does solve the project's drainage problems. Any hydrologic or hydraulic calculations or modeling results must be adequately cited and described in the summary description. If hydrologic or hydraulic models are used, the input and output files for all necessary runs must be included in the appendices. A map showing any drainage area subdivisions used in the analysis must accompany the report.		
4.1g	Proof of Errors and Omissions Insurance for the registered professional engineer or licensed surveyor showing a minimum amount of \$1,000,000 in coverage.		
4.2	A Hydrologic/Hydraulic Analysis, consistent with the methodologies and calculation included in the technical standards, and including the following information:		
4.2a	A hydraulic report detailing existing and proposed drainage patterns on the subject site. The report should include a description of present land use and proposed land use. Any off-site drainage entering the site should be addressed as well. This report should be comprehensive and detail all of the steps		

		the engineer took during the design process.	
4.2b		All hydrologic and hydraulic computations should be included in the submittal. These calculations should include, but are not limited to: runoff curve numbers and runoff coefficients, runoff calculations, stage-discharge relationships, times-of-concentration and storage volumes.	
4.2c		Copies of all computer runs. These computer runs should include both the input and the outputs. Electronic copies of the computer runs with input files will expedite the review process and is required to be submitted.	
4.2d		A set of exhibits should be included showing the drainage sub-areas and a schematic detailing of how the computer models were set up.	
4.2e		A conclusion which summarizes the hydraulic design and details how this design satisfies this Ordinance.	
5. Stormwater Pollution Prevention Plan for Construction Sites			Page/Sheet #
5.1	Construction Plan Elements (Section A in IDEM Form)		
A1	Index of the location of required plan elements in the construction plan		
A2	A vicinity map depicting the project site location in relationship to recognizable local landmarks, towns, and major roads		
A3	Narrative of the nature and purpose of the project		
A4	Latitude and longitude to the nearest fifteen (15) seconds		
A5	Legal description of the project site		
A6	11 X 17-inch plat showing building lot numbers/boundaries and road layout/names		
A7	Boundaries of the one hundred (100) year floodplains, floodway fringes, and floodways		
A8	Land use of all adjacent properties		
A9	Identification of a U.S. EPA approved or established TMDL		
A10	Name(s) of the receiving water(s)		
A11	Identification of discharges to a water on the current 303d list of impaired waters and the pollutant(s) for which it is impaired		
A12	Soil map of the predominant soil types		
A13	Identification and location of all known wetlands, lakes and water courses on or adjacent to the project site (construction plan, existing site layout)		
A14	Identification of any other state or federal water quality permits or authorizations that are required for construction activities		
A15	Identification and delineation of existing cover, including natural buffers		
A16	Existing topography at a contour interval appropriate to indicate drainage patterns		
A17	Location(s) of where run-off enters the project site		
A18	Location(s) of where run-off discharges from the project site prior to land disturbance		
A19	Location of all existing structures on the project site		
A20	Existing permanent retention or detention facilities, including manmade wetlands, designed for the purpose of stormwater management		

A21	Locations where stormwater may be directly discharged into ground water, such as abandoned wells, sinkholes, or karst features	
A22	Size of the project area expressed in acres	
A23	Total expected land disturbance expressed in acres	
A24	Proposed final topography	
A25	Locations and approximate boundaries of all disturbed areas	
A26	Location, size, and dimensions of all stormwater drainage systems, such as culverts, storm sewers, and conveyance channels	
A27	Locations of specific points where stormwater and non-stormwater discharges will leave the project site	
A28	Location of all proposed site improvements, including roads, utilities, lot delineation and identification, proposed structures, and common areas	
A29	Location of all on-site soil stockpiles and borrow areas	
A30	Construction support activities that are expected to be part of the project	
A31	Location of any in-stream activities that are planned for the project including, but not limited to stream crossings and pump arounds	
5.2	Erosion and Sediment Control/Project Site Management (Section B in IDEM Form)	
B1	Description of the potential pollutant generating sources and pollutants, including all potential non-stormwater discharges	
Where applicable, Items in B2 through B10 below will be evaluated for location, dimensions, detailed specifications, and construction details		
B2	Stable construction entrance locations and specifications	
B3	Specifications for temporary and permanent stabilization	
B4	Sediment control measures for concentrated flow areas	
B5	Sediment control measures for sheet flow areas	
B6	Run-off control measures	
B7	Stormwater outlet protection locations and specifications	
B8	Grade stabilization structure locations and specifications	
B9	Dewatering applications and management methods	
B10	Measures utilized for work within waterbodies	
B11	Maintenance guidelines for each proposed temporary stormwater quality measure	
B12	Planned construction sequence describing the relationship between implementation of stormwater quality measures in relation to land disturbance	
B13	Provisions for erosion and sediment control on individual building lots regulated under the proposed project	
B14	Material handling, spill prevention and spill response plan meeting requirements in 327 IAC 2-6.1	
B15	Material handling and storage procedures associated with construction activity	

6. Post-Construction Stormwater Pollution Prevention Plan		Page/Sheet #
6.1	SWPPP – Post-Construction (Section C in IDEM Form)	
C1	Description of pollutants and their sources associated with the proposed land use	
C2	Description of proposed post-construction stormwater measures	
C3	Plan details for each stormwater measure	
C4	Sequence describing stormwater measure implementation	
C5	Maintenance guidelines for proposed post-construction stormwater measures	
C6	Entity that will be responsible for operation and maintenance of the post-construction stormwater measures	
7. Project Check-in Checklist		Page/Sheet #
Must be completed and all items listed must be provided at project submittal.		

Clark County, Indiana	Construction/ Stormwater Pollution Prevention Plan Technical Review Clark County Stormwater Technical Standards IDEM Construction Stormwater General Permit: https://www.in.gov/idem/stormwater/construction-land-disturbance-permitting/ (INRA00000 effective 12/18/2021)
-----------------------	---

Construction/Stormwater Pollution Prevention Plan Technical Review and Comment

Project Name: Scope of Project: County(ies): Latitude: Longitude:	Plan Submittal Date: Click here to enter a date. Plan Review Date: Click here to enter a date.
---	---

Plan Preparer: Address: City: State: Zip: Phone: Cell Phone: Email:	Affiliation:
--	---------------------

Project Site Owner: Address: City: State: Zip: Phone: Cell Phone: Email:	Company Name (if applicable):
---	--------------------------------------

Plan Reviewer: Address: City: State: Zip: Phone: Cell Phone: Email:	Affiliation:	On behalf of:
--	---------------------	----------------------

Plan Review Status:

<input type="checkbox"/>	Plan is Adequate	A comprehensive plan review has been completed and it has been determined that the plan satisfies the minimum requirements of the Clark County Stormwater Ordinance and Technical Standards and the Construction Stormwater General Permit INRA00000 (Effective 12-18-2021).
<input type="checkbox"/>	Preliminary Review	A comprehensive review will not be completed at this time. The plan review authority reserves the right to perform a comprehensive review at a later date, and revisions may be required at that time.
<input type="checkbox"/>	Conditional Acceptance	Acceptance of the plan is conditional. The conditional acceptance is contingent upon addressing the issues identified in the comment sections.
<input type="checkbox"/>	Plan is Deficient	Significant deficiencies were identified and must be addressed. Refer to the comment sections.

Action:

<input type="checkbox"/>	Submit a Notice of Intent: • Submit the Notice of Intent (NOI) online through the IDEM Regulatory ePortal. It is required to upload a copy of this review form when submitting the NOI through the IDEM Regulatory ePortal: https://stormwater.idem.in.gov/ncore/external/home
<input type="checkbox"/>	Do not file a Notice of Intent or commence land-disturbing activities: Deficiencies must be adequately addressed and an acceptable plan review completed.
<input type="checkbox"/>	Comments: Refer to Plan Review Comments Sections of this document.
<input type="checkbox"/>	Revisions: Update and submit the revised Construction/Stormwater Pollution Prevention Plan as indicated below.
<input type="checkbox"/>	Update and submit a complete plan set that addresses plan deficiencies.

<input type="checkbox"/>	Update and submit a document (narrative and/or plan sheets) that address plan deficiencies.
<input type="checkbox"/>	Update and submit a complete plan set that addresses plan deficiencies. A comprehensive plan review will not be completed.

Plan Review Information

- *The technical review and comment is intended to evaluate the completeness of the Construction/Stormwater Pollution Prevention Plan for the project. The Plan submitted was not reviewed for the adequacy of engineering design. All measures included in the plan, as well as those recommended in the comments should be evaluated as to their feasibility by a qualified individual with structural measures designed by a qualified engineer. The Plan has not been reviewed for other local, state, or federal permits that may be required to proceed with this project.*
- *Additional information, including design calculations may be requested to further evaluate the plan.*
- *All proposed stormwater pollution prevention measures and those referenced in this review must meet the design criteria and standards set forth in the "Indiana Stormwater Quality Manual" from the Indiana Department of Environmental Management or similar Guidance Documents.*
- *Construction activities and unforeseen weather conditions may affect the performance of the erosion and sediment control system, individual measures, or the effectiveness of the plan. The plan must be a flexible document, with provisions to modify or substitute measures as necessary to ensure compliance.*

Section A: Construction Plan Elements

Adequate	Deficient	NA	A	
				<i>The construction plan elements include general information associated with the project site that are critical for the evaluation of the stormwater pollution prevention plan component. This information includes, but is not limited to an index, resource information, reference maps, grading information, project layout and design, and drainage plan</i>
<input type="checkbox"/>	<input type="checkbox"/>	<input type="checkbox"/>	1	Index of the location of required plan elements in the construction plan
<input type="checkbox"/>	<input type="checkbox"/>	<input type="checkbox"/>	2	A vicinity map depicting the project site location in relationship to recognizable local landmarks, towns, and major roads
<input type="checkbox"/>	<input type="checkbox"/>	<input type="checkbox"/>	3	Narrative of the nature and purpose of the project
<input type="checkbox"/>	<input type="checkbox"/>	<input type="checkbox"/>	4	Latitude and longitude to the nearest fifteen (15) seconds
<input type="checkbox"/>	<input type="checkbox"/>	<input type="checkbox"/>	5	Legal description of the project site
<input type="checkbox"/>	<input type="checkbox"/>	<input type="checkbox"/>	6	11 X 17-inch plat showing building lot numbers/boundaries and road layout/names
<input type="checkbox"/>	<input type="checkbox"/>	<input type="checkbox"/>	7	Boundaries of the one hundred (100) year floodplains, floodway fringes, and floodways
<input type="checkbox"/>	<input type="checkbox"/>	<input type="checkbox"/>	8	Land use of all adjacent properties
<input type="checkbox"/>	<input type="checkbox"/>	<input type="checkbox"/>	9	Identification of a U.S. EPA approved or established TMDL
<input type="checkbox"/>	<input type="checkbox"/>	<input type="checkbox"/>	10	Name(s) of the receiving water(s)
<input type="checkbox"/>	<input type="checkbox"/>	<input type="checkbox"/>	11	Identification of discharges to a water on the current 303d list of impaired waters and the pollutant(s) for which it is impaired
<input type="checkbox"/>	<input type="checkbox"/>	<input type="checkbox"/>	12	Soil map of the predominant soil types
<input type="checkbox"/>	<input type="checkbox"/>	<input type="checkbox"/>	13	Identification and location of all known wetlands, lakes and water courses on or adjacent to the project site (construction plan, existing site layout)
<input type="checkbox"/>	<input type="checkbox"/>	<input type="checkbox"/>	14	Identification of any other state or federal water quality permits or authorizations that are required for construction activities
<input type="checkbox"/>	<input type="checkbox"/>	<input type="checkbox"/>	15	Identification and delineation of existing cover, including natural buffers
<input type="checkbox"/>	<input type="checkbox"/>	<input type="checkbox"/>	16	Existing topography at a contour interval appropriate to indicate drainage patterns

<input type="checkbox"/>	<input type="checkbox"/>	<input type="checkbox"/>	17	Location(s) of where run-off enters the project site
<input type="checkbox"/>	<input type="checkbox"/>	<input type="checkbox"/>	18	Location(s) of where run-off discharges from the project site prior to land disturbance
<input type="checkbox"/>	<input type="checkbox"/>	<input type="checkbox"/>	19	Location of all existing structures on the project site
<input type="checkbox"/>	<input type="checkbox"/>	<input type="checkbox"/>	20	Existing permanent retention or detention facilities, including manmade wetlands, designed for the purpose of stormwater management
<input type="checkbox"/>	<input type="checkbox"/>	<input type="checkbox"/>	21	Locations where stormwater may be directly discharged into ground water, such as abandoned wells, sinkholes, or karst features
<input type="checkbox"/>	<input type="checkbox"/>	<input type="checkbox"/>	22	Size of the project area expressed in acres
Adequate	Deficient	NA	A	<i>The construction plan elements include general information associated with the project site that are critical for the evaluation of the stormwater pollution prevention plan component. This information includes, but is not limited to an index, resource information, reference maps, grading information, project layout and design, and drainage plan</i>
<input type="checkbox"/>	<input type="checkbox"/>	<input type="checkbox"/>	23	Total expected land disturbance expressed in acres
<input type="checkbox"/>	<input type="checkbox"/>	<input type="checkbox"/>	24	Proposed final topography
<input type="checkbox"/>	<input type="checkbox"/>	<input type="checkbox"/>	25	Locations and approximate boundaries of all disturbed areas
<input type="checkbox"/>	<input type="checkbox"/>	<input type="checkbox"/>	26	Location, size, and dimensions of all stormwater drainage systems, such as culverts, storm sewers, and conveyance channels
<input type="checkbox"/>	<input type="checkbox"/>	<input type="checkbox"/>	27	Locations of specific points where stormwater and non-stormwater discharges will leave the project site
<input type="checkbox"/>	<input type="checkbox"/>	<input type="checkbox"/>	28	Location of all proposed site improvements, including roads, utilities, lot delineation and identification, proposed structures, and common areas
<input type="checkbox"/>	<input type="checkbox"/>	<input type="checkbox"/>	29	Location of all on-site soil stockpiles and borrow areas
<input type="checkbox"/>	<input type="checkbox"/>	<input type="checkbox"/>	30	Construction support activities that are expected to be part of the project
<input type="checkbox"/>	<input type="checkbox"/>	<input type="checkbox"/>	31	Location of any in-stream activities that are planned for the project including, but not limited to stream crossings and pump arounds

Section A – Comments:

- Evaluate areas with potential waters of the state and, where required, verify if permits/authorizations are required prior to any impacts to waters of the state. These potential resources include areas with hydric soil, hydrophytic vegetation, pooling water, or evidence of flowing water such as swales, ditches, drains, or natural conveyances. Evaluation of hydric soil, hydrophytic vegetation, or pooling water should conform to the US Army Corps of Engineers Wetlands Delineation Manual," Technical Report Y-87-1, and the applicable regional supplement https://www.usace.army.mil/Missions/Civil-Works/Regulatory-Program-and-Permits/reg_supp/. Avoidance and minimization of impacts to waters of the state should be prioritized.

Section B: Stormwater Pollution Prevention Plan – Erosion and Sediment Control/Project Site Management

Adequate	Deficient	NA	B	<i>The construction component of the Stormwater Pollution Prevention Plan includes stormwater quality measures to address erosion, sedimentation, and other pollutants associated with land disturbance and construction activities. Proper implementation of the plan, maintenance of measures, and administering a self-monitoring program is required to manage the project site to minimize the discharge of sediment and other pollutants. Construction activities and unforeseen weather conditions may affect the performance of the erosion and sediment control system, individual measures, or the effectiveness of the plan. The plan must be a flexible document, with provisions to modify or substitute measures as necessary to ensure compliance.</i>
<input type="checkbox"/>	<input type="checkbox"/>	<input type="checkbox"/>	1	Description of the potential pollutant generating sources and pollutants, including all potential non-stormwater discharges Where applicable, Items in 2 through 10 below will be evaluated for Location, dimensions, detailed specifications, and construction details
<input type="checkbox"/>	<input type="checkbox"/>	<input type="checkbox"/>	2	Stable construction entrance locations and specifications
<input type="checkbox"/>	<input type="checkbox"/>	<input type="checkbox"/>	3	Specifications for temporary and permanent stabilization
<input type="checkbox"/>	<input type="checkbox"/>	<input type="checkbox"/>	4	Sediment control measures for concentrated flow areas
<input type="checkbox"/>	<input type="checkbox"/>	<input type="checkbox"/>	5	Sediment control measures for sheet flow areas
<input type="checkbox"/>	<input type="checkbox"/>	<input type="checkbox"/>	6	Run-off control measures
<input type="checkbox"/>	<input type="checkbox"/>	<input type="checkbox"/>	7	Stormwater outlet protection locations and specifications
<input type="checkbox"/>	<input type="checkbox"/>	<input type="checkbox"/>	8	Grade stabilization structure locations and specifications
<input type="checkbox"/>	<input type="checkbox"/>	<input type="checkbox"/>	9	Dewatering applications and management methods
<input type="checkbox"/>	<input type="checkbox"/>	<input type="checkbox"/>	10	Measures utilized for work within waterbodies
<input type="checkbox"/>	<input type="checkbox"/>	<input type="checkbox"/>	11	Maintenance guidelines for each proposed temporary stormwater quality measure
<input type="checkbox"/>	<input type="checkbox"/>	<input type="checkbox"/>	12	Planned construction sequence describing the relationship between implementation of stormwater quality measures in relation to land disturbance
<input type="checkbox"/>	<input type="checkbox"/>	<input type="checkbox"/>	13	Provisions for erosion and sediment control on individual building lots regulated under the proposed project
<input type="checkbox"/>	<input type="checkbox"/>	<input type="checkbox"/>	14	Material handling and spill prevention and spill response plan meeting the requirements in 327 IAC 2-6.1
<input type="checkbox"/>	<input type="checkbox"/>	<input type="checkbox"/>	15	Material handling and storage procedures associated with construction activity

Section B – Comments:

- Stormwater quality measures for the reduction of sediment have not been evaluated for adequacy of design. The proposed measures included in this SWPPP are being accepted based on the design engineer’s submittal.

Section C: Stormwater Pollution Prevention Plan – Post-Construction

Adequate	Deficient	NA	C	
<i>The post-construction component of the Stormwater Pollution Prevention Plan includes the implementation of stormwater quality measures to address pollutants that will be associated with the final project land use. Post-construction stormwater measures should be functional upon completion of the project. Long term functionality of the measures is critical to their performance and should be monitored and maintained.</i>				
<input type="checkbox"/>	<input type="checkbox"/>	<input type="checkbox"/>	1	Description of pollutants and their sources associated with the proposed land use
<input type="checkbox"/>	<input type="checkbox"/>	<input type="checkbox"/>	2	Description of proposed post-construction stormwater measures
<input type="checkbox"/>	<input type="checkbox"/>	<input type="checkbox"/>	3	Plan details for each stormwater measure
<input type="checkbox"/>	<input type="checkbox"/>	<input type="checkbox"/>	4	Sequence describing stormwater measure implementation
<input type="checkbox"/>	<input type="checkbox"/>	<input type="checkbox"/>	5	Maintenance guidelines for proposed post-construction stormwater measures
<input type="checkbox"/>	<input type="checkbox"/>	<input type="checkbox"/>	6	Entity that will be responsible for operation and maintenance of the post-construction stormwater measures

Section C – Comments:

- Post-construction stormwater quality and quantity measures have not been evaluated for adequacy of design. The proposed measures included in this SWPPP are being accepted based on the design engineer's submittal.
- The rate of stormwater run-off and/or volume from the project site must meet local requirements to address stormwater quantity as established by ordinance or other regulatory mechanism. When a local requirement does not exist, the post-development run-off discharge from the project site must not exceed the pre-development discharge based on the two-year, ten-year, and one-hundred-year peak storm events.

Statement of Financial Responsibility

The undersigned of the proposed project to be known as

do hereby agree to take full responsibility of financial payment of review fees incurred on the above project. I am aware that the review fees will begin as soon as a permit application is filed and continues until the project is approved and/or withdrawn. I understand that if the project is withdrawn the review fees are still due and payable from the application date to the date on the letter of withdrawal. No project will receive an approval letter nor will the plat be approved for recording until all fees are paid. All review fees are made payable to the CCDB or designee.

The undersigned, having duly sworn upon oath, that the above information has been read and fully understood to be true and correct and is (undersigned) voluntary act and deed. The undersigned assumes responsibility for the aforementioned fees.

Signature

Mailing Address

Signature Printed

City, State, Zip Code

STATE OF INDIANA)

COUNTY OF _____)

Subscribed and sworn before me, a Notary Public, within and for said County and State, this _____ day of _____, 20____.

My Commission Expires _____

Notary Public _____

(Notary Stamp or Seal)

Stormwater Management BMPs Maintenance Agreement

THIS AGREEMENT is made this _____ day of _____, 20____, by _____ [Owner Name] of _____ [Company Name] with principal offices located _____ [Owner/Company Address], hereinafter "Owner".

In accordance with Clark County Stormwater Ordinance and Technical Standards, the Owner agrees to install and maintain stormwater management practice(s) (also known as BMPs) on the subject property, known as _____ [Property's Common Name] located at _____ [Property's Address], hereinafter "Property" in accordance with Exhibit A. The Owner further agrees to the terms stated in this document to ensure that the stormwater management practice(s) continues serving the intended function in perpetuity. This Agreement includes the following exhibit:

Exhibit A: BMP Operation and Maintenance Manual ("Manual").

Note: This agreement and all Exhibits shall be recorded with the deed of property by the Owner at the Clark County Recorder's Office and two (2) copies of the recorded document provided to CCDB or designee's Office, hereinafter "Community".

Through this Agreement, the Owner hereby subjects the Property to the following covenants, conditions, and restrictions:

1. The Owner shall be solely responsible for the installation, maintenance, and repair of the stormwater management practices, drainage easements, and associated landscaping identified in the Manual.
2. No alterations or changes to the stormwater management practice(s) identified in the Manual shall be permitted unless they are deemed to comply with this Agreement and are approved in writing by the Community.
3. The Owner shall retain the services of a qualified individual or company to operate and ensure the maintenance of the stormwater management practice(s) identified in the Manual.
4. The Owner shall annually, by December 30th, provide to the Community records of inspections, maintenance, and repair of the stormwater management practices in accordance with the Manual.
5. The Community or its designee is authorized to access the property as necessary to conduct inspections of the stormwater management practices or drainage easements to ascertain compliance with the intent of this Agreement and the activities prescribed in the Manual. Upon written notification by the Community or its designee of required maintenance or repairs, the Owner shall complete the specified maintenance or repairs within a reasonable time frame determined by the Community. The Owner(s) shall be liable for the failure to undertake any maintenance or repairs so that the public health, safety and welfare shall not be endangered nor the road improvement damaged.
6. If the Owner fails to properly maintain the stormwater management practice(s) in accordance with the Manual and this Agreement, the Community is authorized, but not required, to perform the specified inspections, maintenance, or repairs in order to preserve the intended functions of the practice(s) and prevent the practice(s) from becoming a threat to public health, safety, general welfare or the environment. In the case of an emergency, as determined by the Community, no notice shall be required prior to the Community performing emergency maintenance or repairs. The Community may levy the costs and expenses of such inspections, maintenance, or repairs plus a ten percent (10%) administrative fee against the Owner. The Community at the time of entering upon said stormwater management practice for the purpose of maintenance or repair may file a notice of lien in the office of the Register of Deeds of Clark County upon the property affected by the lien. If said costs and expenses are not paid by the Owner, the Community may pursue the collection of same through appropriate court actions and in such a case, the Owner shall pay in addition to said costs and expenses all costs of litigation, including attorney fees.

7. The Owner hereby conveys to the Community an easement over, on, and in the Property or otherwise grants perpetual access rights for the purpose of access to the stormwater management practice for the inspection, maintenance, and repair thereof, should the Owner fail to properly inspect, maintain, and repair the practice(s).
8. The Owner agrees that this Agreement shall be recorded and that the Property shall be subject to the covenants and obligations contained herein, and this Agreement shall bind all current and future owners of the property.
9. The Owner agrees in the event that the Property is sold, transferred, or leased to provide information to the new owner, operator, or lessee regarding proper inspection, maintenance, and repair of the stormwater management practice(s). The information shall accompany the first deed transfer and include this Agreement and all Exhibits. The transfer of this information shall also be required with any subsequent sale, transfer, or lease of the Property.
10. The Owner agrees that the rights, obligations, and responsibilities hereunder shall commence upon execution of the Agreement.
11. The Owner whose signatures appear below hereby represent and warrant that they have the authority and capacity to sign this agreement and bind the respective parties hereto.
12. The Owner, its agents, representatives, successors, and assigns shall defend, indemnify and hold the Community harmless from and against any claims, demands, actions, damages, injuries, costs or expenses of any nature whatsoever, hereinafter "Claims", fixed or contingent, known or unknown, arising out of or in any way connected with the design, construction, use, maintenance, repair or operation (or omissions in such regard) of the stormwater management practice(s) referred to in Exhibit A which are the subject of this Agreement. This indemnity and hold harmless shall include any costs, expenses, and attorney fees incurred by the Community in connection with such Claims or the enforcement of this Agreement.

IN WITNESS WHEREOF, the Owner has executed this Agreement on the day and year first above written.

Owner Signature

Date

Printed Name

Company

Title

STATE OF INDIANA)
)
COUNTY OF ~~xxx~~)

SS:

BEFORE ME, the undersigned, a Notary Public in and for said County and State, personally appeared _____ Owner subscribed and sworn before this _____ day of _____, 20 ____.

Commission Expiration Date

County of Residence

Signature

Printed Name

WHEN RECORDED, RETURN FILE STAMPED COPY TO:

Clark County *Name and Address*

.....
Accepted by CCDB or designee:

Signature: _____

Date: _____

Printed Name: _____

Title: _____

Project Check-In Checklist

Project Name: _____

Engineer: _____ **Contact Person:** _____

Address: _____

Phone Number: _____ **Fax Number:** _____

Developer/Owner: _____ **Contact Person:** _____

Address: _____

Phone Number: _____ **Fax Number:** _____

Project Information:

Section: _____ **Township:** _____ **Range:** _____

Township: _____ **City:** _____

Number of Lots: _____ **Acres:** _____

Parcel Number: _____ **Reg. Drain:** _____

Accepted Drainage Footage:

Open: _____ **Tile:** _____

Checklist:

1 Copy of Petition Signed & Notarized by Owner: _____

1 Copy of Legal Description: _____ 2 Sets of Plans: _____

1 Copy of Engineer Statement: _____ 1 CD (with complete project submittal): _____

1 Copy of application checklist: _____ 1 Check for Application Fee: _____

1 Copy of Stormwater Drainage Technical Report: _____

1 Copy of Stormwater Pollution Prevention Plan for Construction Sites: _____

1 Copy of Post-Construction Stormwater Pollution Prevention Plan: _____

Original Letter and 1 copy of Financial Responsibility: _____

1 Copy of Project Check-In Checklist (this sheet): _____

OFFICE USE ONLY

Assessment: _____

Revisions: _____

Approval: _____

Denial: _____

B2 – Construction Inspection/Completion Forms

**Construction Self-Monitoring Report
Certification of Completion & Compliance
Termination Inspection Checklist**

Self-Monitoring Report (To Be Completed by Permittee's Trained Individual)

PART A: INSPECTION INFORMATION

Project Name: CSGP Project # Number: Permit # Assigned by MS4: Name of MS4: County: Name of Evaluator: Title of Evaluator: Affiliation: Email/Phone Number:	Inspection Type	Inspection Date and Time	
	<input type="checkbox"/> 24 hr (after >.5" rain) <input type="checkbox"/> 24 hr (before >.5" rain) <input type="checkbox"/> Weekly <input type="checkbox"/> Monthly <i>(only applies to areas permanently stabilized)</i>	Click here to enter a date.	
		Date of Last or Forecasted (circle one) Precipitation: Click here to enter a date.	
(only applies to areas permanently stabilized)		Amount of Last or Forecasted (circle one) Precipitation: Click here to enter a date.	

PART B: SITE CONDITIONS

Current Site Information (check all that apply): Clearing Grubbing Grading Building Construction
 Installation of Infrastructure Utility Work Vegetative Establishment Other:

Soil Conditions: Dry Moist Wet Muddy Partial Snow Cover Snow Cover Frozen Freeze/Thaw
 Other:

PART C: PROJECT MANAGEMENT

(1) Was the SWP3 accessible at the time of the inspection?	<input type="checkbox"/> Yes <input type="checkbox"/> No
(2) Is the SWP3 current and/or updated to reflect the current stage of development?	<input type="checkbox"/> Yes <input type="checkbox"/> No
(3) Have all action items identified on the preceding reports been resolved? (a) If not identify which items require repair and provide a resolution timeline:	<input type="checkbox"/> Yes <input type="checkbox"/> No
(4) Is the project posting information posted in accordance with the CSGP Section 3.7?	<input type="checkbox"/> Yes <input type="checkbox"/> No

PART D: GUIDANCE FOR COMPLETION OF FORM

- Identify all areas of the site that currently have an erosion/sediment control measure in place. Using Part E, evaluate the current condition of the measure and using the middle column, determine what action needs to be taken.
- Identify all areas of the site where stormwater run-off leaves site or where any discharge occurs. In each location where run-off leave the site, evaluate:
 - If an erosion/sediment control measure is in place: evaluate each action step required in Part E
 - If no erosion/sediment control measure is in place or a measure is required, use Part E to include specifics about the location and type of measure to be implemented.
- For any area of the site where there is run-off, or a discharge provide a description and location using Part F.
 - If any sedimentation is occurring note where it is discharging: Off site, to a waterbody (on or off-site) or other sensitive area
- For Part H in the Evaluation of sheet flow and concentrated run-off:
 - Identify location of discharge/run-off and check any visual descriptions that apply to the discharge. If the discharge/run-off will resolve with the repair of a sediment or erosion control measure or good housekeeping practices, you do not need to list an action in the observations/notes section. If the discharge/run-off will not be solved with repair/replacement of a sediment control measure or good housekeeping practices, you will need to list the action taken to resolve the run-off and any additional pollutants visible in the discharge.

o Print out additional pages for Parts E and F.

PART E: SEDIMENT CONTROL AND RUN-OFF MANAGEMENT

Measure: Location(s):	<input type="checkbox"/> No Action Required <input type="checkbox"/> Maintenance Required <input type="checkbox"/> Repair Measure <input type="checkbox"/> Temporary Measure <input type="checkbox"/> Replace Measure <input type="checkbox"/> Alternative Measure <input type="checkbox"/> Additional Measure	Observations/Notes:
Action Initiated Date: Click here to enter a date. Initials:		Action Completed Date: Click here to enter a date. Initials
Measure: Location(s):	<input type="checkbox"/> No Action Required <input type="checkbox"/> Maintenance Required <input type="checkbox"/> Repair Measure <input type="checkbox"/> Temporary Measure <input type="checkbox"/> Replace Measure <input type="checkbox"/> Alternative Measure <input type="checkbox"/> Additional Measure	Observations/Notes:
Action Initiated Date: Click here to enter a date. Initials:		Action Completed Date: Click here to enter a date. Initials
Measure: Location(s):	<input type="checkbox"/> No Action Required <input type="checkbox"/> Maintenance Required <input type="checkbox"/> Repair Measure <input type="checkbox"/> Temporary Measure <input type="checkbox"/> Replace Measure <input type="checkbox"/> Alternative Measure <input type="checkbox"/> Additional Measure	Observations/Notes:
Action Initiated Date: Click here to enter a date. Initials:		Action Completed Date: Click here to enter a date. Initials
Measure: Location(s):	<input type="checkbox"/> No Action Required <input type="checkbox"/> Maintenance Required <input type="checkbox"/> Repair Measure <input type="checkbox"/> Temporary Measure <input type="checkbox"/> Replace Measure <input type="checkbox"/> Alternative Measure <input type="checkbox"/> Additional Measure	Observations/Notes:

Action Initiated Date: Click here to enter a date. Initials:		Action Completed Date: Click here to enter a date. Initials	
Measure: Location(s):	<input type="checkbox"/> No Action Required <input type="checkbox"/> Maintenance Required <input type="checkbox"/> Repair Measure <input type="checkbox"/> Temporary Measure <input type="checkbox"/> Replace Measure <input type="checkbox"/> Alternative Measure <input type="checkbox"/> Additional Measure	Observations/Notes:	
Action Initiated Date: Click here to enter a date. Initials:		Action Completed Date: Click here to enter a date. Initials	

PART F: SURFACE STABILIZATION

Location(s):	<input type="checkbox"/> Permanent Vegetative Cover: <input type="checkbox"/> Continue to Monitor <input type="checkbox"/> 70 Percent Density Achieved <input type="checkbox"/> Perform Seeding/Reseed <input type="checkbox"/> Temporary <input type="checkbox"/> Permanent <input type="checkbox"/> Apply straw mulch and anchor <input type="checkbox"/> Install Erosion Control Blanket <input type="checkbox"/> Repair Erosion <input type="checkbox"/> Utilize Alternative Stabilization Method	Observations/Notes:
--------------	--	---------------------

Action Initiated Date: Click here to enter a date. Initials:	Action Completed Date: Click here to enter a date. Initials
--	---

Location(s):	<input type="checkbox"/> Permanent Vegetative Cover: <input type="checkbox"/> Continue to Monitor <input type="checkbox"/> 70 Percent Density Achieved <input type="checkbox"/> Perform Seeding/Reseed <input type="checkbox"/> Temporary <input type="checkbox"/> Permanent <input type="checkbox"/> Apply straw mulch and anchor <input type="checkbox"/> Install Erosion Control Blanket <input type="checkbox"/> Repair Erosion <input type="checkbox"/> Utilize Alternative Stabilization Method	Observations/Notes:
--------------	--	---------------------

Action Initiated Date: Click here to enter a date. Initials:	Action Completed Date: Click here to enter a date. Initials
--	---

Location(s):	<input type="checkbox"/> Permanent Vegetative Cover: <input type="checkbox"/> Continue to Monitor <input type="checkbox"/> 70 Percent Density Achieved <input type="checkbox"/> Perform Seeding/Reseed <input type="checkbox"/> Temporary <input type="checkbox"/> Permanent <input type="checkbox"/> Apply straw mulch and anchor <input type="checkbox"/> Install Erosion Control Blanket <input type="checkbox"/> Repair Erosion <input type="checkbox"/> Utilize Alternative Stabilization Method	Observations/Notes:
--------------	--	---------------------

Action Initiated Date: Click here to enter a date. Initials:	Action Completed Date: Click here to enter a date. Initials
--	---

Location(s):	<input type="checkbox"/> Permanent Vegetative Cover: <input type="checkbox"/> Continue to Monitor <input type="checkbox"/> 70 Percent Density Achieved <input type="checkbox"/> Perform Seeding/Reseed <input type="checkbox"/> Temporary <input type="checkbox"/> Permanent <input type="checkbox"/> Apply straw mulch and anchor <input type="checkbox"/> Install Erosion Control Blanket <input type="checkbox"/> Repair Erosion <input type="checkbox"/> Utilize Alternative Stabilization Method	Observations/Notes:
--------------	--	---------------------

Action Initiated Date: Click here to enter a date. Initials:	Action Completed Date: Click here to enter a date. Initials
--	---

PART G: GOOD HOUSEKEEPING

Site Ingress/Egress Location(s):	<input type="checkbox"/> Maintain Construction Entrance <input type="checkbox"/> Remove Tracked Sediment (do not flush sediment) <input type="checkbox"/> Install Additional Measures	Observations/Notes:
--	---	---------------------

Action Initiated Date: Click here to enter a date. Initials:	Action Completed Date: Click here to enter a date. Initials
--	---

Trash Location(s):	<input type="checkbox"/> Continue to Monitor and Manage <input type="checkbox"/> Cover Trash Receptacles <input type="checkbox"/> Clean Up Wind-blown Trash <input type="checkbox"/> Other	Observations/Notes:
------------------------------	---	---------------------

Action Initiated Date: Click here to enter a date. Initials:	Action Completed Date: Click here to enter a date. Initials
--	---

Spills or Leaks Location(s):	Type of Leak/Spill <input type="checkbox"/> Concrete and/or Cementitious Washout <input type="checkbox"/> Fuel <input type="checkbox"/> Other	Observations/Notes/Action Taken:
--	--	----------------------------------

Action Initiated Date: Click here to enter a date. Initials:	Action Completed Date: Click here to enter a date. Initials
--	---

PART H: EVALUATION OF SHEET FLOW AND CONCENTRATED RUN-OFF (DISCHARGES)

Location(s):	<input type="checkbox"/> Sediment <input type="checkbox"/> Oil Sheen <input type="checkbox"/> Odor <input type="checkbox"/> Floatables/Trash <input type="checkbox"/> Foam <input type="checkbox"/> Color/Turbid Discharge <input type="checkbox"/> Other	Observations/Notes:
--------------	---	---------------------

Action Initiated Date: Click here to enter a date. Initials:	Action Completed Date: Click here to enter a date. Initials
--	---

Location(s):	<input type="checkbox"/> Sediment <input type="checkbox"/> Oil Sheen <input type="checkbox"/> Odor <input type="checkbox"/> Floatables/Trash <input type="checkbox"/> Foam <input type="checkbox"/> Color/Turbid Discharge <input type="checkbox"/> Other	Observations/Notes:
--------------	---	---------------------

Action Initiated Date: Click here to enter a date. Initials:	Action Completed Date: Click here to enter a date. Initials
--	---

PART I: CHANGES TO SWPPP

Does the corrective action based on this inspection require modification to the SWPPP? Yes No

Date of SWPPP update:

Brief description of the changes:

Action Initiated Date: Click here to enter a date. Initials:	Action Completed Date: Click here to enter a date. Initials
--	---

PART J: TRAINED INDIVIDUAL CERTIFICATION

I certify that Part A-I of this evaluation were evaluated by me as a trained individual. To the best of my knowledge and belief, the information documented in the report is true, accurate, and complete.

Evaluator Name and Title:

Signature and Date: _____

CERTIFICATE OF COMPLETION & COMPLIANCE

Name of project: _____

Address of premises on which land alteration was accomplished: _____

Inspection Date(s): _____ Stormwater Permit Number: _____

Relative to plans prepared by: _____ on _____
_____ (date)

I hereby certify that:

1. I am familiar with drainage requirements applicable to such land alteration (as set forth in the Stormwater Management Ordinance of Clark County); and
2. I (or a person under my direct supervision) have personally inspected the completed work and examined the drainage permit and its conditions, as-built plans, and final drainage calculations consistent with as-built conditions performed pursuant to the above referenced drainage permit; and
3. To the best of my knowledge, information, and belief, such land alteration has been performed and completed in conformity with all such drainage requirements, except _____

Signature: _____

Date: _____

Typed or Printed Name: _____

Phone: () _____

(SEAL)

Business Address: _____

SURVEYOR

ENGINEER

(circle one)

Indiana Registration No. _____

TERMINATION INSPECTION CHECKLIST

(To Be Completed by CCDB or designee)

1. Compliance Requirements

All construction sites shall undergo a final inspection by the CCDB or designee prior to submittal of a Notice of Termination (NOT) to IDEM by the project owner to document the site is stabilized, temporary BMPs have been removed and no future land disturbance will occur within the permitted boundaries. A completed copy of this form confirming compliance with project termination requirements, signed by the CCDB or designee representative, is required to be sent by the applicant to IDEM along with the NOT.

2. Inspection Details

Project Name:	
Address/Lot #:	
IDEM Permit No. ("INR" followed by 6 digits):	
Inspection Performed By:	Date:

3. Notice of Termination (NOT) Verification Inspection Items

ITEM	YES	NO	N/A
A. Have all earth disturbing activities been completed?	<input type="checkbox"/>	<input type="checkbox"/>	<input type="checkbox"/>
B. Are all soils stabilized as appropriate?	<input type="checkbox"/>	<input type="checkbox"/>	<input type="checkbox"/>
C. Are all drainageways stabilized with either vegetation, rip rap, or other armament?	<input type="checkbox"/>	<input type="checkbox"/>	<input type="checkbox"/>
D. Have all temporary erosion and sediment control measures been removed?	<input type="checkbox"/>	<input type="checkbox"/>	<input type="checkbox"/>
E. Has all construction waste, trash, and debris been removed from the site?	<input type="checkbox"/>	<input type="checkbox"/>	<input type="checkbox"/>
F. Has all construction equipment and material been removed from the site?	<input type="checkbox"/>	<input type="checkbox"/>	<input type="checkbox"/>
G. Are all the permanent BMPs free of sediment accumulation resulting from construction activities?	<input type="checkbox"/>	<input type="checkbox"/>	<input type="checkbox"/>

4. Corrective Actions Required (If Applicable) If you answered "no" to any of the above questions, describe any corrective action which must be taken to remedy the problem and when the corrective actions are to be completed.

Attach additional sheet(s) if needed

5. Compliance Assessment

<input type="checkbox"/> DEFICIENT – Applicant must schedule a re-inspection by <u>Jurisdictional Entity</u> after deficiencies are addressed.
<input type="checkbox"/> COMPLIANT – Applicant must upload a signed copy to IDEM along with the IDEM NOT online submittal.

6. Certification and Signature

Inspector Name and Title:	Phone:
Inspector Signature:	Date:

B3 - Individual Lot/Parcel Permit Forms

Instructions for Individual Lot Permit Request
Individual Lot Permit Request Application
Typical Erosion & Sediment Control Plan and Certification
Plot Plan Review Form
Individual Lot Stormwater Pollution Prevention Requirements

INSTRUCTIONS FOR INDIVIDUAL LOT PERMIT REQUEST

1. Request shall be made to the CCDB or designee.
2. Request shall be made on standard form only, supplied by the CCDB or designee.
3. The form shall be completely filled out, including the following information:
 - a. Name of subdivision/minor plat and lot number.
 - b. Section/Township/Range
 - c. Parcel number of property involved.
 - d. Project name (if none then put individual's name).
 - e. Contact person(s).
 - f. Type of residential lot and/or improvement. This office may require more details depending on the type of improvements being proposed.
4. A certified Plot Plan, including site layout is required to be submitted with each permit application.
5. An erosion and sediment control plan is required to be submitted with each permit application.
6. Applicant will need to provide the name, address telephone number, and list of qualifications of the trained individual in charge of the mandatory stormwater pollution prevention self-monitoring program for the project site.
7. Applicant will need to abide by any additional requirements set forth in the Clark County Stormwater Management Ordinance and/or Technical Standards.
8. The applicant or an agent of the applicant must sign the form.
9. Check or money order is to be made payable to the CCDB or designee. The correct amount of fee, based on the Fee Ordinance, must be included with the application package.

INDIVIDUAL LOT PERMIT REQUEST

Name of Subdivision/Minor Plat & Lot #: _____ Project Name: _____
Parcel Number: _____ Section/Township/Range _____
Township Name: _____

Applicant's Name: _____ Property Owner: _____
Address: _____ Property Address: _____

Phone: () _____ Phone: () _____
Fax: () _____ Fax: () _____

Contractor/Builder: _____
Address: _____
Phone: () _____ Fax: () _____
Contact Person: _____ Cell Phone: _____

Type of Residential Lot or Improvement: _____

Trained Individual in Charge of the Mandatory Stormwater Pollution Prevention Program Name: _____
Address: _____ Phone #: _____
List of Qualifications): _____

The individual lot operator is responsible for installation and maintenance of all erosion and sediment control measures until the site is stabilized.

_____ Date _____ Signature _____
Check Title: Owner _____ Contractor _____ Engineer _____ Agent _____ Other _____

*** For Office Use Only *** Engineering Firm: _____ Permit # _____ Plan Project # _____ Check # _____

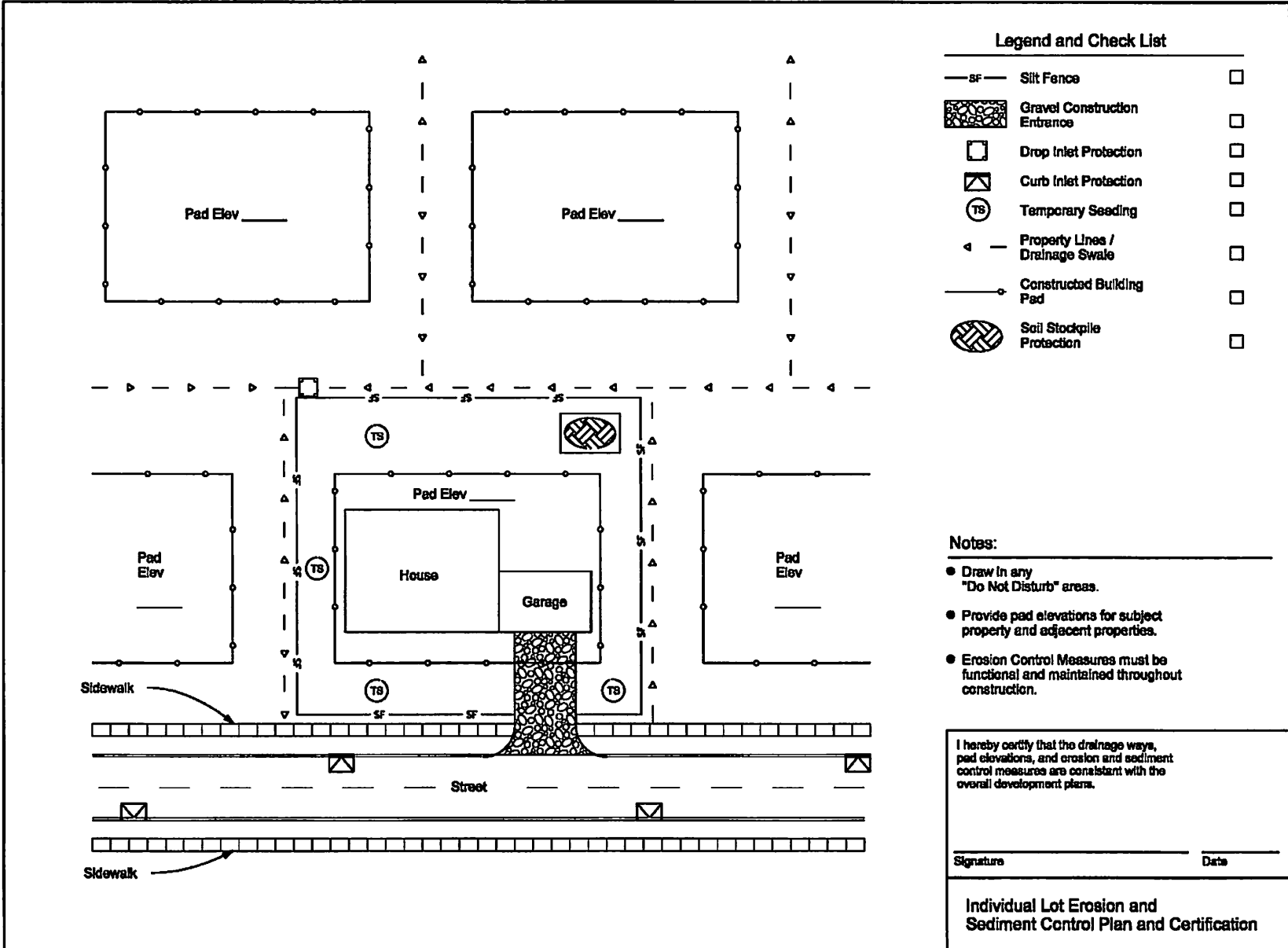

Legend and Check List

— SF —	Slit Fence	<input type="checkbox"/>
	Gravel Construction Entrance	<input type="checkbox"/>
	Drop Inlet Protection	<input type="checkbox"/>
	Curb Inlet Protection	<input type="checkbox"/>
	Temporary Seeding	<input type="checkbox"/>
	Property Lines / Drainage Swale	<input type="checkbox"/>
	Constructed Building Pad	<input type="checkbox"/>
	Soil Stockpile Protection	<input type="checkbox"/>

Notes:

- Draw in any "Do Not Disturb" areas.
- Provide pad elevations for subject property and adjacent properties.
- Erosion Control Measures must be functional and maintained throughout construction.

I hereby certify that the drainage ways, pad elevations, and erosion and sediment control measures are consistent with the overall development plans.

Signature _____

Date _____

Individual Lot Erosion and Sediment Control Plan and Certification

Plot Plan Review

Landowner _____ Parcel # _____
Legal Description _____ Erosion Fee _____

- Legal Description
- Stamped by Engineer/Surveyor _____
- "N" arrow and scale
- Site/location map
- Flood Zone _____ Map # _____
- Check for Wetland
- Dimension of Lot
 - House finish floor 2' above road elevation
 - House finish floor in relationship to pond normal pool
 - Driveway location not over curb inlets or storm sewers
 - Show utilities
 - Water
 - Sanitary
 - Septic with perimeter tile location & outlet with elevations
 - 8" tile, storm piping, or regulated drain
 - Swales
 - Elevations-centerline of road
 - Inlet/outlet elevations
 - Benchmark
 - Easements
 - Field verified elevations
- Erosion Control
 - * Temporary Driveway or construction entrance
 - * Lot Stabilization – silt fence or equivalent
 - * Curb or Yard inlet stabilization
 - * Pond protection
 - * Street protection
 - * Seeding-permanent, temporary (timeline)
 - * Undisturbed area marked
 - * Stockpile area marked and protected

*Endangered species area

* Responsible Individual _____

Additional Comments: _____

Reviewed By: _____ Date Received: _____

Date Reviewed: _____ Revisions: _____ Approval Number: _____

Date Approved: _____ Date Taken to Planning: _____

Called: _____ Faxed Comments: _____

Individual Lot/Parcel Stormwater Pollution Prevention Requirements

FOR COMPLIANCE WITH CLARK COUNTY STORMWATER CODE

THE INDIVIDUAL LOT OWNER OR OPERATOR IS RESPONSIBLE FOR THE INSTALLATION AND MAINTENANCE OF STORMWATER POLLUTION PREVENTION CONTROLS UNTIL THE ENTIRE LOT IS COMPLETE AND 100% STABILIZED.

- Initial Stormwater controls such as construction entrances, curbside and rear of lot storm inlet protection (geo-textile wrapped under grate is prohibited), and perimeter controls (typically silt fence) must be in place BEFORE ANY LOT DISTURBANCE begins.
- All construction materials must be staged off of the street and on the lot behind perimeter controls.
- Portable toilets must be kept off of the street and should be placed on even ground on the lot behind perimeter controls.
- All lots must provide and utilize appropriate trash containment for site waste.
- Contractors must use appropriate practices for concrete, mortar, and paint washout. These materials must be properly contained and NOT enter the storm drains or other conveyances.
- Any off site tracking of sediment into the street, or off site sedimentation into swales or drains MUST be cleaned as soon as possible and by no later than the end of the day.
- Lot frontage should be cleaned and acceptable in appearance at the end of every business day.
- Areas where operations have impacted adjacent lots or rear yard swales MUST be repaired to design condition and 100% stabilized.

PLEASE NOTE: ANY INSPECTION WILL FAIL IF THE CORRECT STORMWATER POLLUTION PREVENTION CONTROLS ARE NOT IN PLACE AND PROPERLY MAINTAINED.

Stormwater Pollution Prevention Controls on Individual Lots

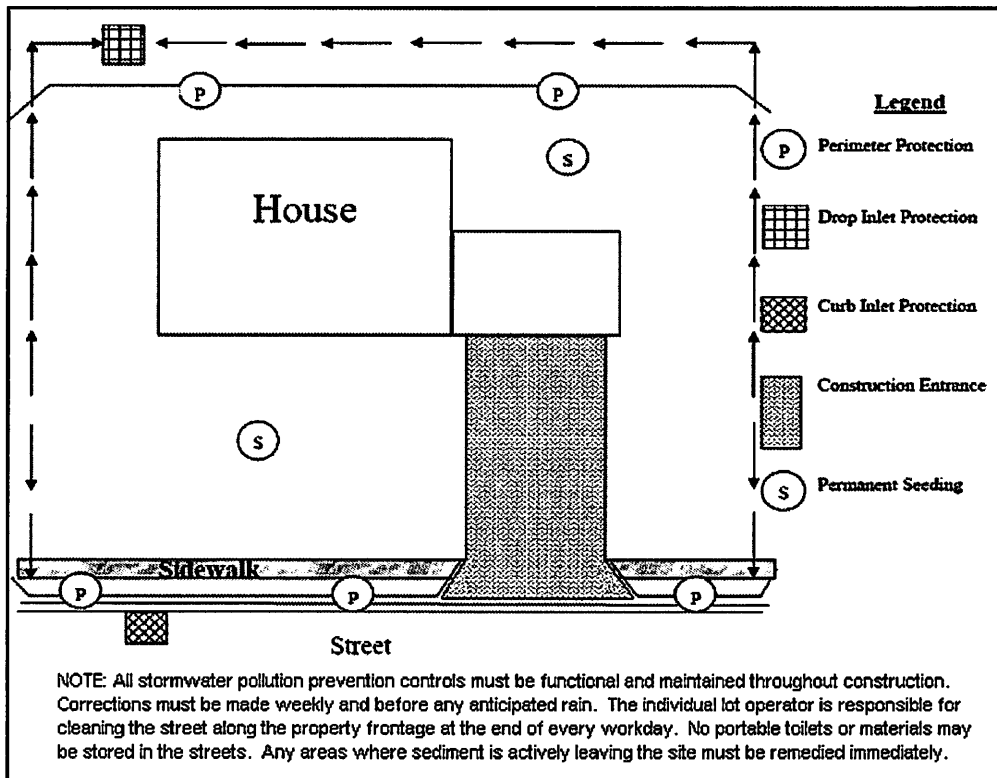

Construction Sequence

1. Install construction entrance.
 - a. Use #2 stone. Flare entrance at street so it can handle vehicle turn radius. See Detail.
2. Install perimeter protection.
 - a. Protection along the sides of the lot is only necessary if the adjacent lot is built out or if stormwater runoff will drain in that direction.
 - b. Make sure perimeter protections are turned into the lot where they terminate to create a ponding area. See above diagram.
 - c. Rear of lot perimeter protection should be installed to protect the rear yard swale.
3. Install protections on storm inlets at curbside and at rear of lot.
 - a. Geo-textile or "fabric" wrapped underneath the grate is **PROHIBITED**.
 - b. Make sure curbside inlet protection leaves the top 3-4 inches of the storm grate exposed to allow for overflow to enter the storm inlet, preventing ponding.
4. Lot disturbance may begin once the controls listed above are in place.
5. Maintain lot controls at all times and repair as soon as possible when a correction is needed.
 - a. If sediment is actively leaving the site due to a failing control such as tracking or an operation such as dewatering, it must be corrected **IMMEDIATELY**.
6. Stabilize all exposed soils with vegetation, mulch, or stone when construction is complete.
 - a. Lot is considered stabilized once vegetation has reached 100% coverage and 70 % density.
7. Remove temporary stormwater pollution prevention controls.
 - a. These may be removed when exposed soils have been stabilized with vegetation, sod, or mulch.
 - b. Seed alone is not a stabilization measure until it germinates and achieves proper coverage.

BMP DETAILS

Silt Fence

1. Install silt fence parallel to the contour of the land.
2. Extend ends of silt fence upslope 3-4 feet to allow for ponding areas behind the fence.
3. Excavate trench 8 inches deep and 4 inches wide.
4. Install with stakes on the down slope side of fence.
5. Bury 12 inches of fabric in the trench, extending the bottom 4 inches toward the upslope side.
6. Backfill trench on both sides of fence and compact.
7. Join silt fence sections by wrapping two posts and driving them in together. Do not use any other method of joining.

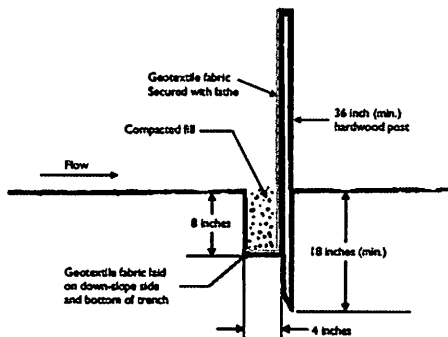

8. Inspect weekly and within 24 hrs of a ½" of rain. Silt fence should be cleaned out when the sediment has reached 1/3 the height of the exposed fencing. Repair silt fence where torn or damaged. Complete repairs before the next anticipated rain and by no later than one week from the date they are noticed.

Construction Entrance

1. Install construction entrance from street to face of proposed building or at a 50' minimum length. Use #2 stone at a 6" minimum depth.
2. A geo-textile is required underneath the entrance to extend its functionality.
3. Flare out entrance where it meets the street so that vehicle turn radiuses do not travel over disturbed ground.

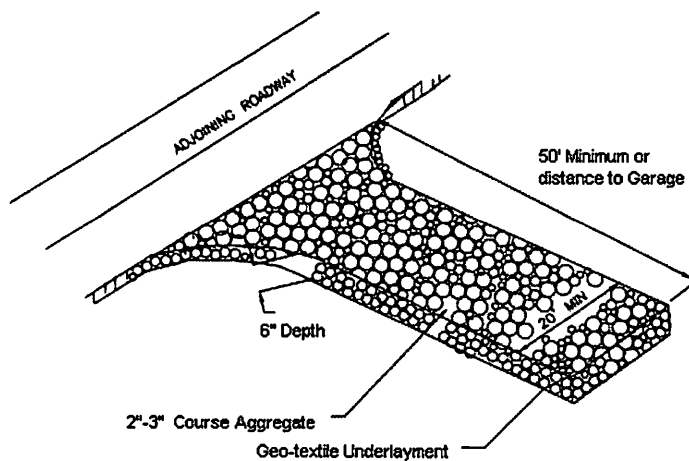

4. Perimeter Controls (silt fence) should be turned into the lot for a few feet where they meet the construction entrance.
5. Inspect weekly and within 24 hrs of a ½” of rain. Freshen or replace stone as needed to prevent off site tracking. If offsite tracking is occurring, clean up immediately, and correct the reason why the drive is failing as soon as possible. Complete repairs before the next anticipated rain and by no later than one week from the date they are noted.

Inlet Protection

1. Install inlet protection on all curbside and rear of lot storm
2. Curbside inlet protection should be installed so that 3 – 4 inches of the top of the casting is exposed to allow for overflow, preventing excessive ponding.
3. Wrapping geo-textile underneath the grate for protection or straw bale barriers are PROHIBITED practices.
4. Make sure inlet protection is securely fastened to the storm grate and installed per the manufacturer’s recommendations.

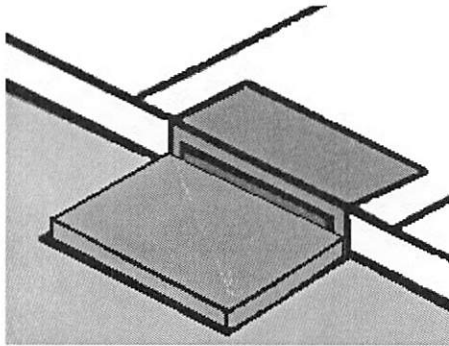

5. Inspect weekly and within 24 hours of a ½” of rain. Sediment accumulation or standing water around the inlet can indicate the need for maintenance. Clean protection when clogged with sediment or when it reaches ½ of the storage capacity or height of the control. Replace protection if torn or worn. Clean sediment from street around the storm inlet and place back onto lot behind perimeter controls. Complete repairs before the next anticipated rain and by no later than one week from the day they are noted.